



KUBO “CORNER ENTRY”

MANUALE D'INSTALLAZIONE, USO e MANUTENZIONE
MANUAL FOR USE, INSTALLATION and MAINTENANCE
NOTICE D'INSTALLATION, D'UTILISATION et D'ENTRETIEN
INSTALLATIONS-, BETRIEBS- und WARTUNGSHANDBUCH
MANUAL DE INSTALACIÓN, USO y MANTENIMIENTO
HANDLEIDING voor de INSTALLATIE, het GEBRUIK en het ONDERHOUD
ΕΓΧΕΙΡΙΔΙΟ ΤΟΠΟΘΕΤΗΣΗΣ, ΧΡΗΣΗΣ και ΣΥΝΤΗΡΗΣΗΣ
РУКОВОДСТВО ПО МОНТАЖУ, ЭКСПЛУАТАЦИИ И ТЕХНИЧЕСКОМУ ОБСЛУЖИВАНИЮ
NÁVOD NA INSTALACI, POUŽITÍ A ÚDRŽBU
NÁVOD NA INŠTALÁCIU, POUŽITIE A ÚDRŽBU
PRIROČNIK ZA INSTALACIJO, UPORABO in VZDRŽEVANJE
PRIRUČNIK ZA INSTALIRANJE, UPOTREBU i ODRŽAVANJE

Notes on this manual

Partial or total reproduction or copying of this manual without the permission of the manufacturer is prohibited. The contents of this manual are subject to change with no advance notice. Every effort has been made in preparing this manual to ensure the accuracy of its contents. However, if you have any questions or discover any errors, please contact the manufacturer. The manufacturer shall not be held liable for consequences arising from use of the product. The drawings and diagrams contained in the manual are to be considered approximate and are provided only for information



SALES RULES AND REGULATIONS



The manufacture recommends carefully reading this booklet

- The manual is provided together with the product and must be kept for future consultation during the entire life of the product and must be transferred to any product owner or installer.
- The product must be installed without many any modifications, under penalty of warranty cancellation. The assembly procedures, tools and materials that are indicated must be respected.
- The product was designed and built for installation on a masonry wall: if installed on another type of wall (ex. plasterboard, wood, etc.), the installer is responsible for providing reinforcement to ensure the secure installation of the product.
- For silicon sealing, use acetic silicon.



When installation is complete, remove all packaging items and installation waste according to the current regulations of the country of product use.



ROUTINE MAINTENANCE OF SHOWER ENCLOSURE AND VISIBLE PARTS

Lime scale and aggressive detergents may make the surface of the shower enclosure opaque over time.

The Manufacturer suggests the following:

Never use powder detergents. Liquid detergents may be used if they are free of alcoholic substances.

Never use products such as ammonia, acetone, alcohol and the like because they may permanently damage the shower enclosure.

After use, your shower should be cleaned with soap and water. This is particularly important in hard water districts where insoluble lime salts may be deposited and allowed to build up.

Cleaners of a gritty or abrasive nature should not be used. Care should be taken to avoid contact with strong chemicals such as organic solvents and strippers.

Glass cleaners can be used but with caution, if in doubt, contact the manufacturer of the cleaner in question.

Please keep these instructions for aftercare and customer service details.

GUIDE TO INSTRUCTIONS



Installation PHASE



sequence of the OPERATIONS to be performed during a PHASE

PR2 component identification

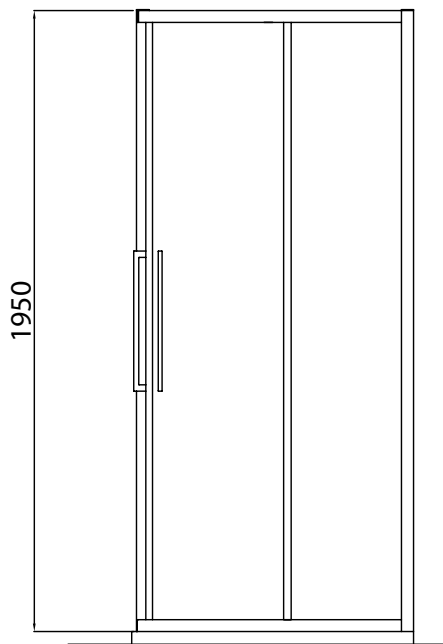
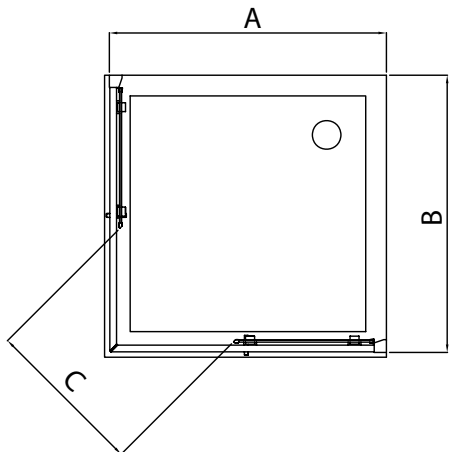

Corner entry enclosure	Dim. A Width (mm)	Dim. B Width (mm)	Dim. C Opening (mm)
760	715 - 740	715 - 740	395
800	755 - 780	755 - 780	425
900	855 - 880	855 - 880	495

TOOLS NECESSARY FOR INSTALLATION

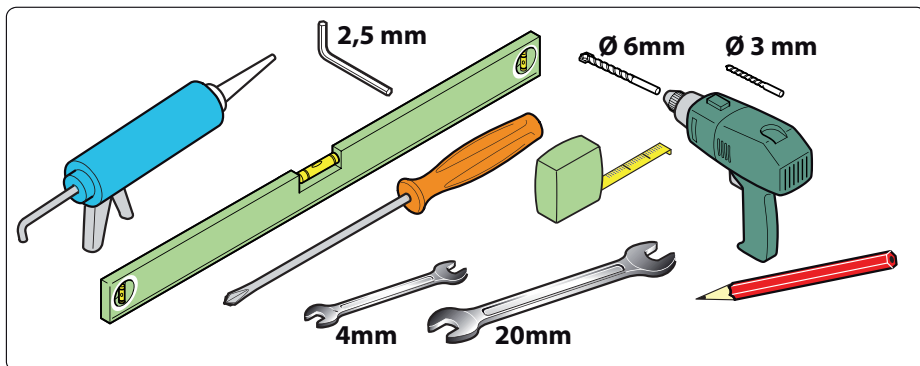

This product is heavy and may require two people to install

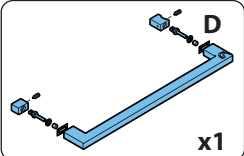
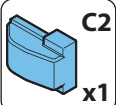
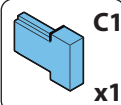
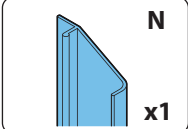
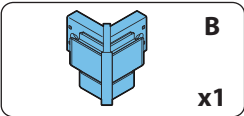
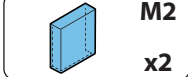
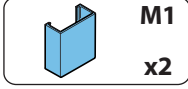
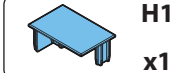
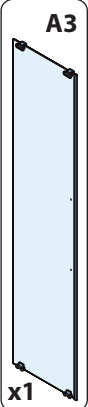
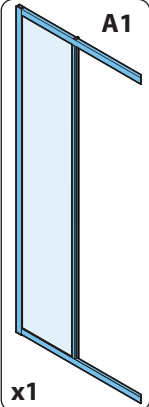
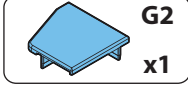
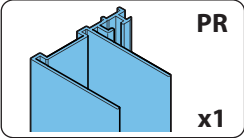
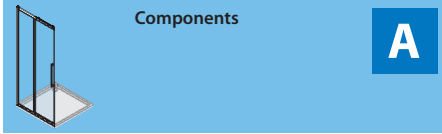

TCB 3,9x35

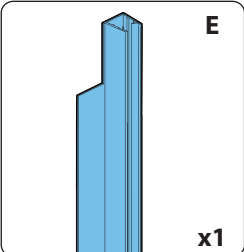
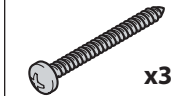

TCB 3,9x9

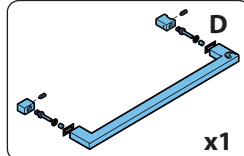
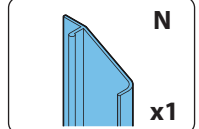
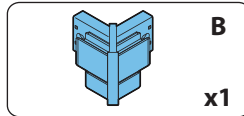
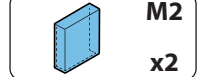
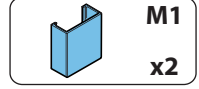
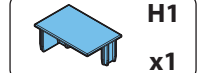
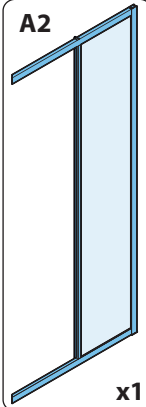
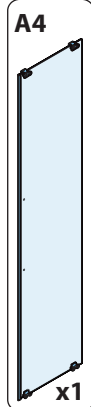
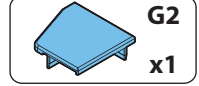
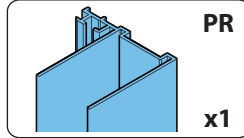

TCB 3,9x35

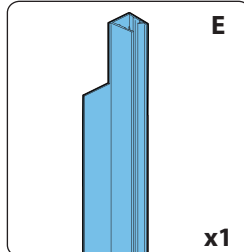
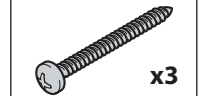

TCB 3,9x9



**ATTENTION!**

- Ensure tray is level and firm
- Tray **MUST** be sealed before enclosure installation begins
- It is recommended that shower enclosures are fitted onto a tiled wall surface.
- Wall fixing supplied are for solid wall construction
- Substitute suitable fixing as appropriate
- Door is not handed

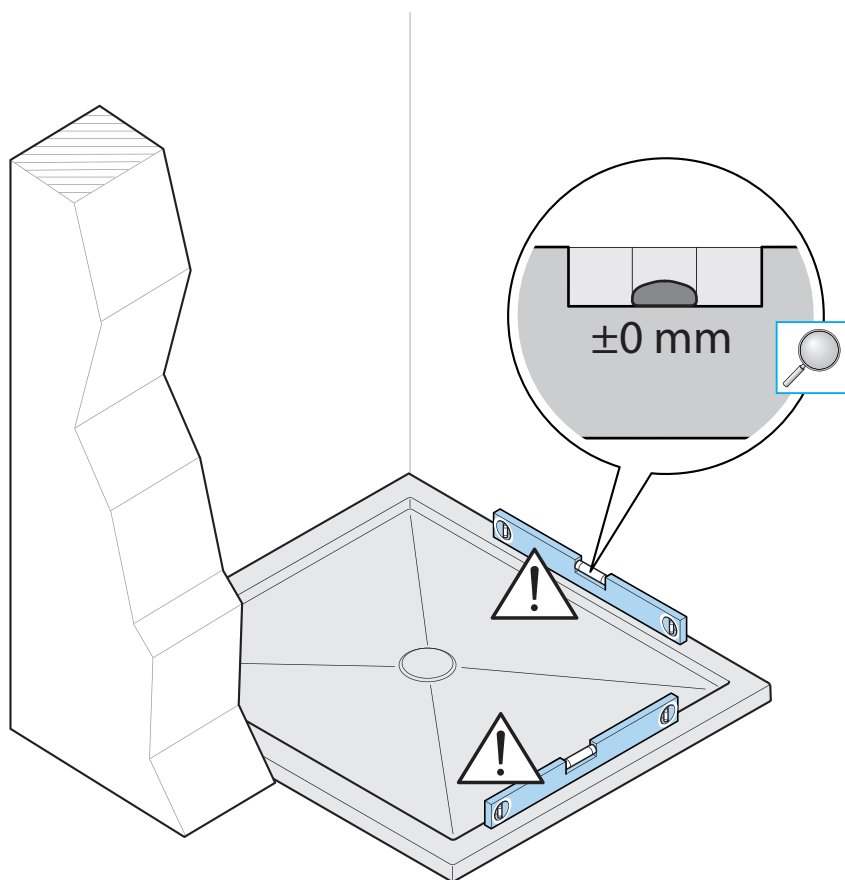

2

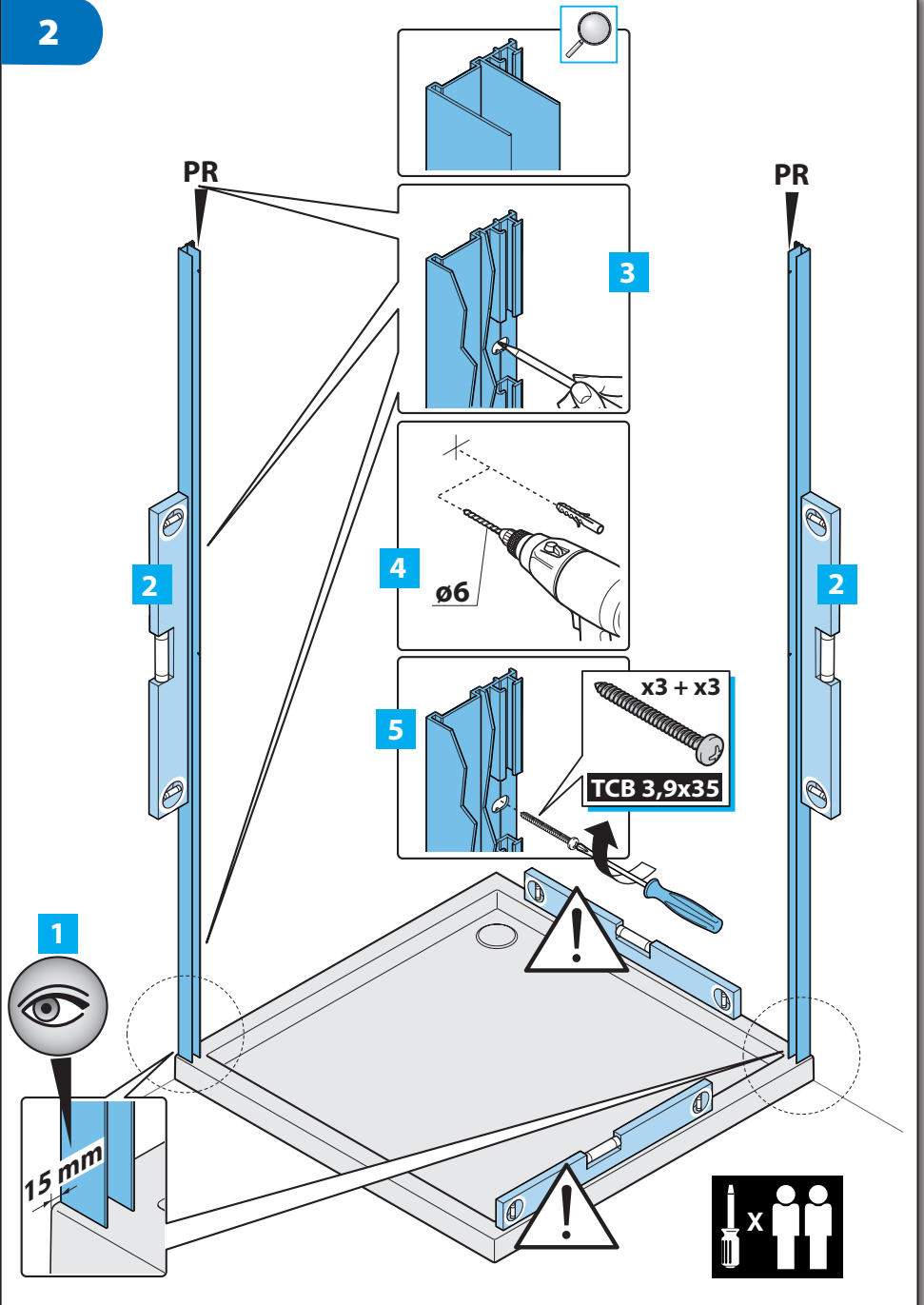

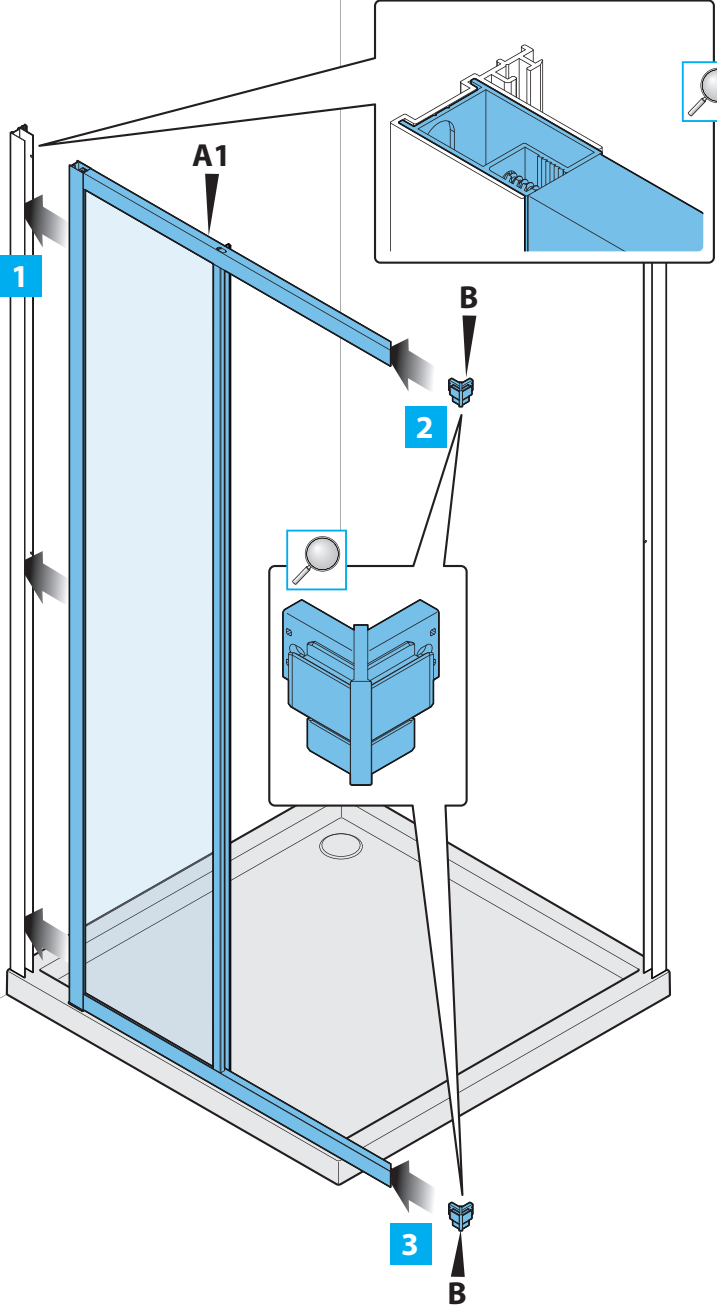

4

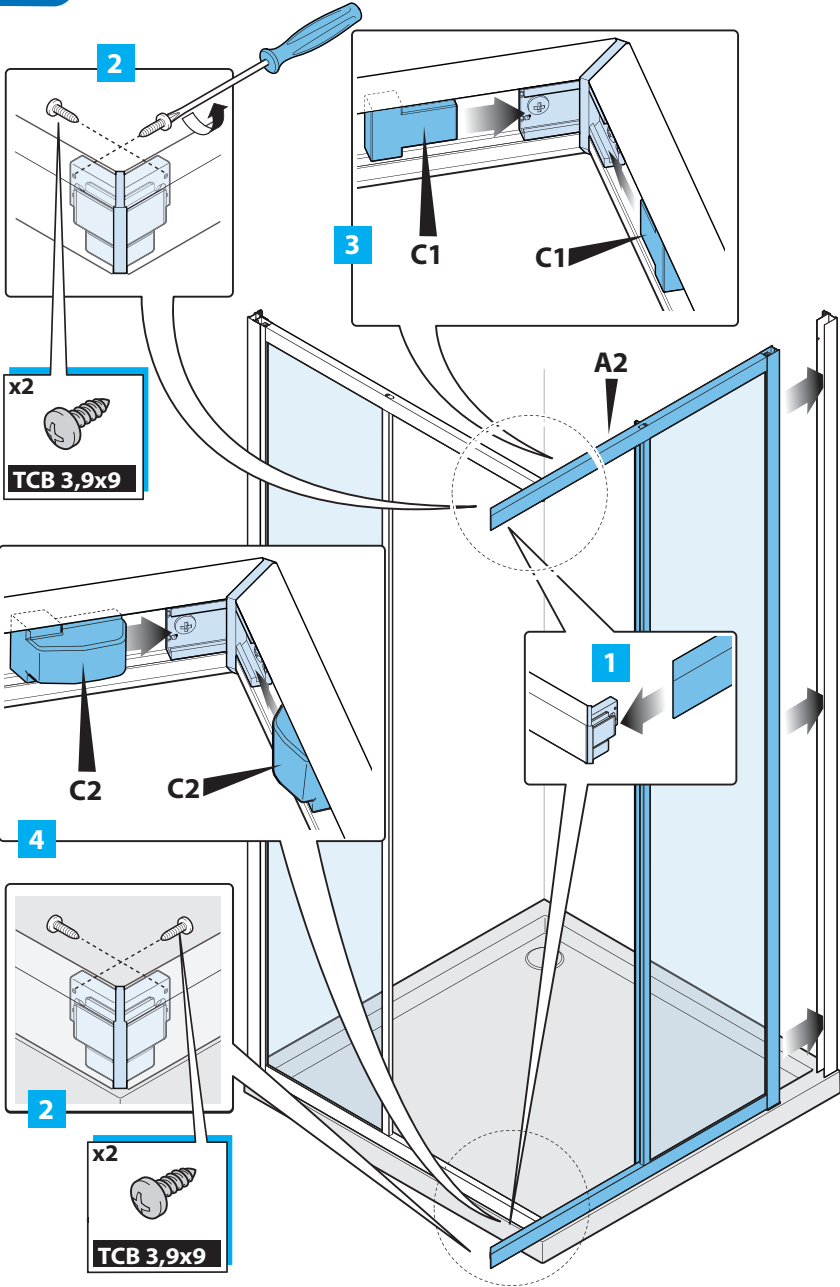

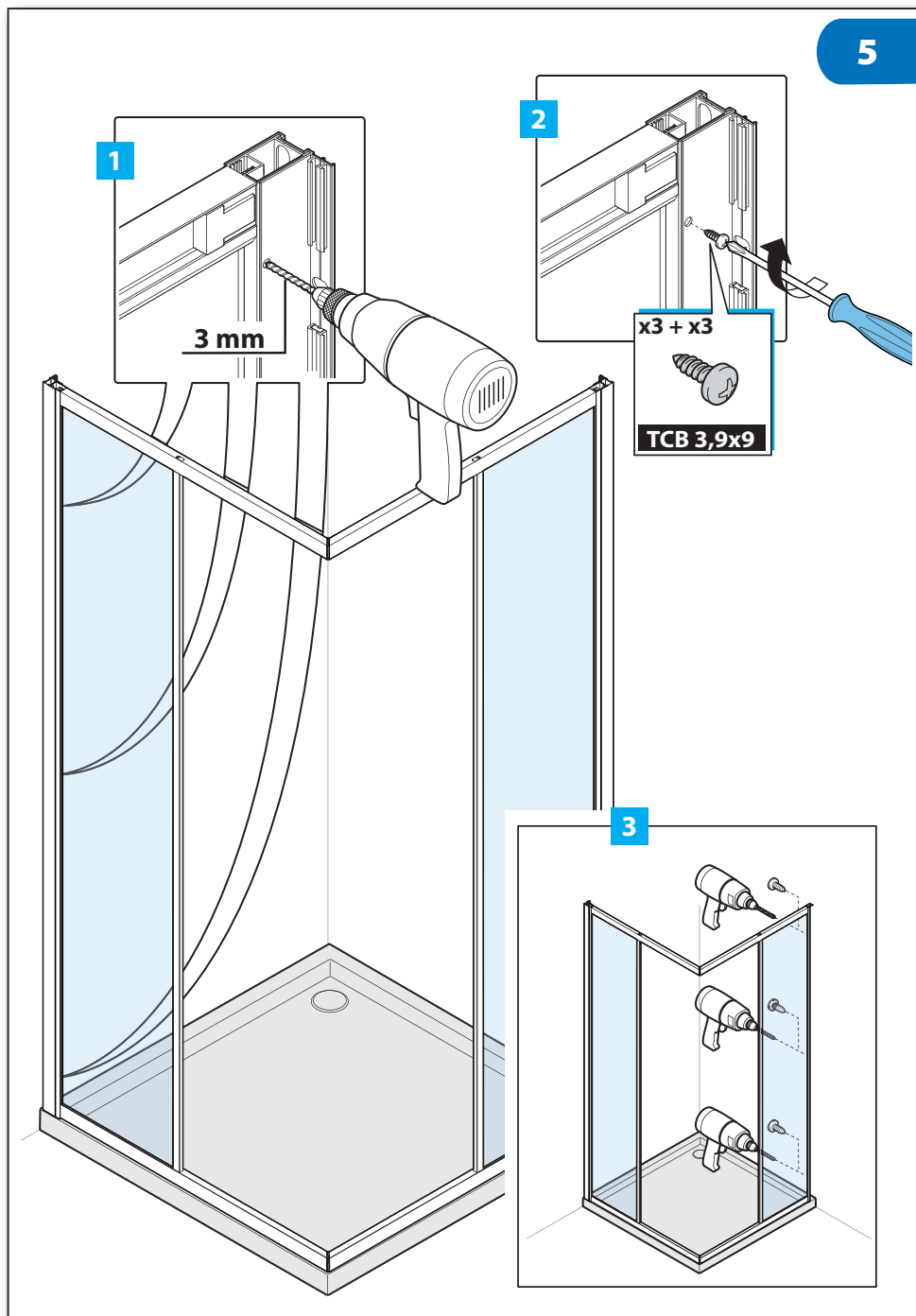

6

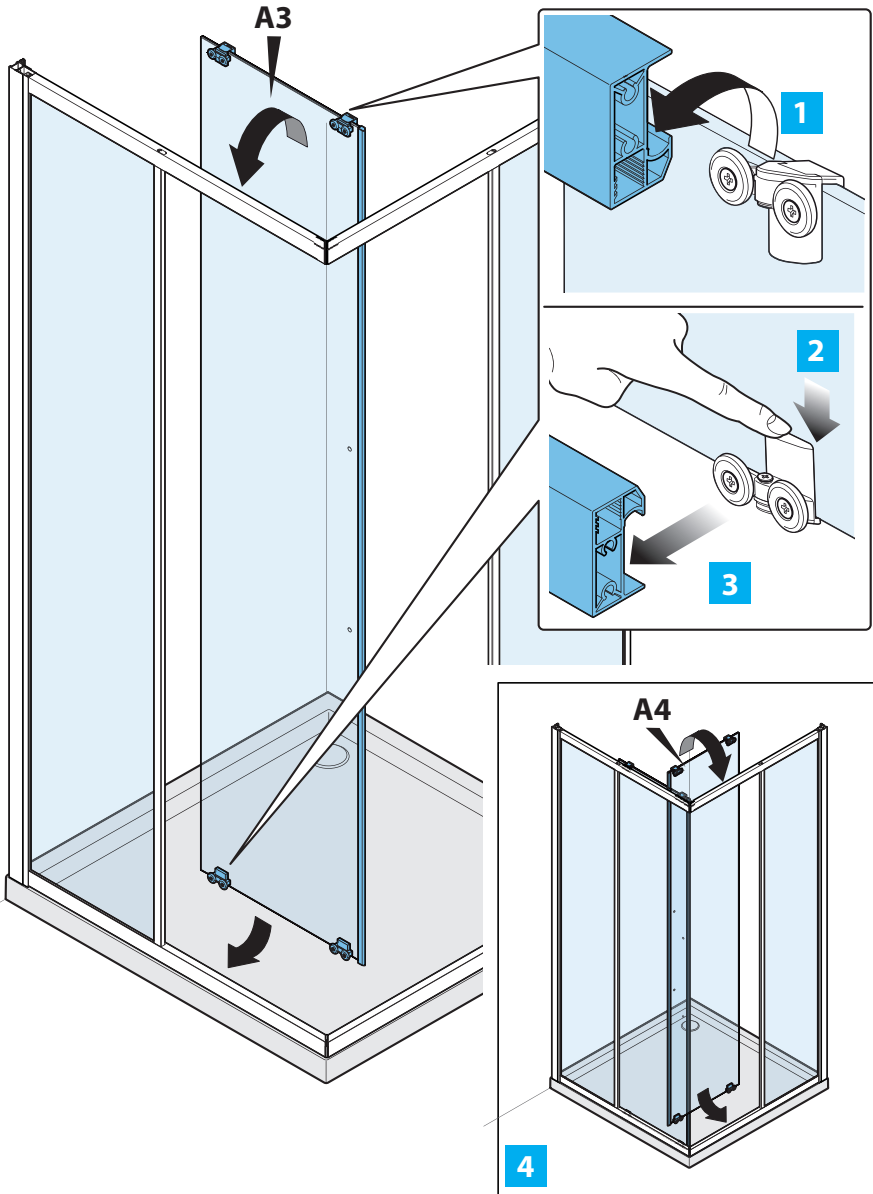

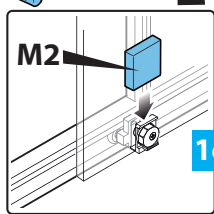
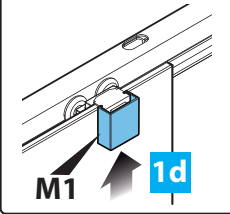
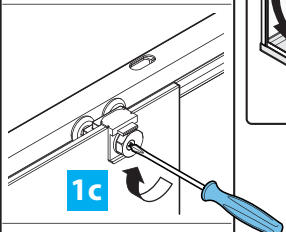
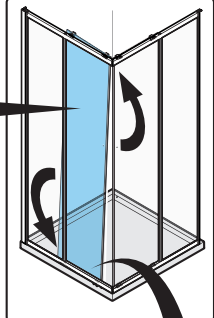
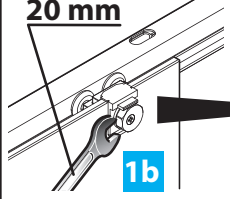
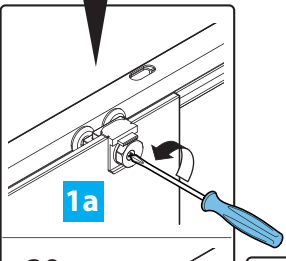
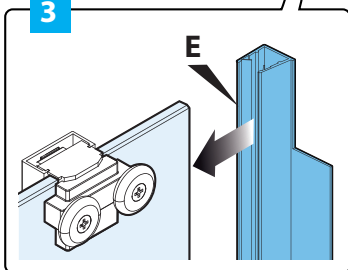
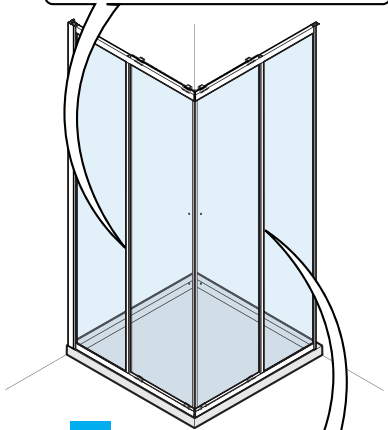
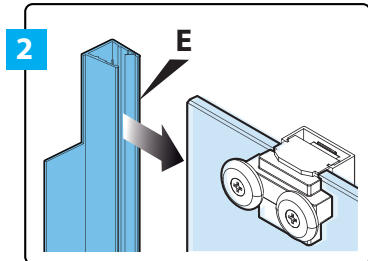
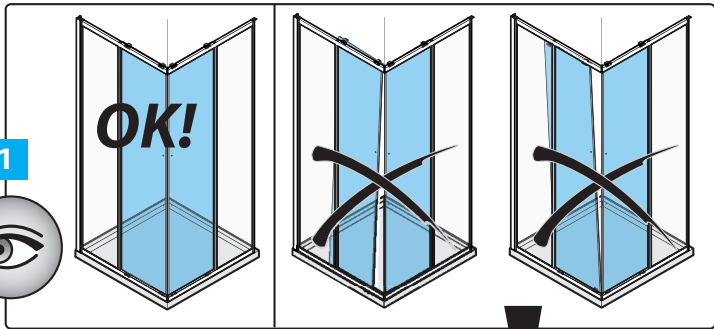

8

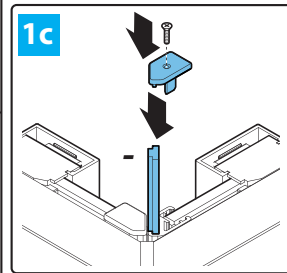
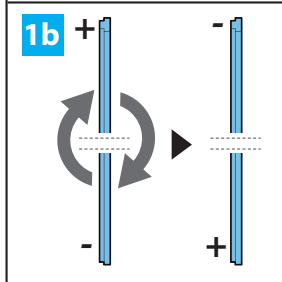
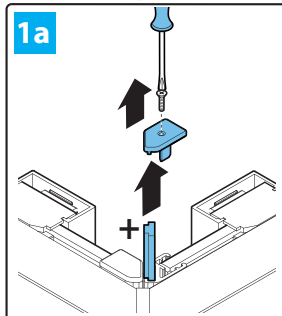
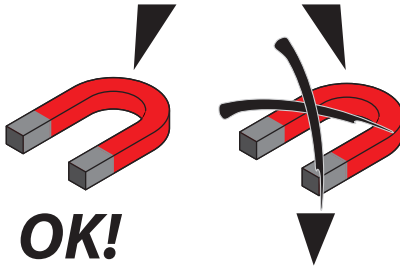
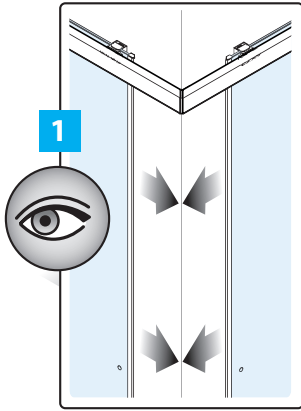

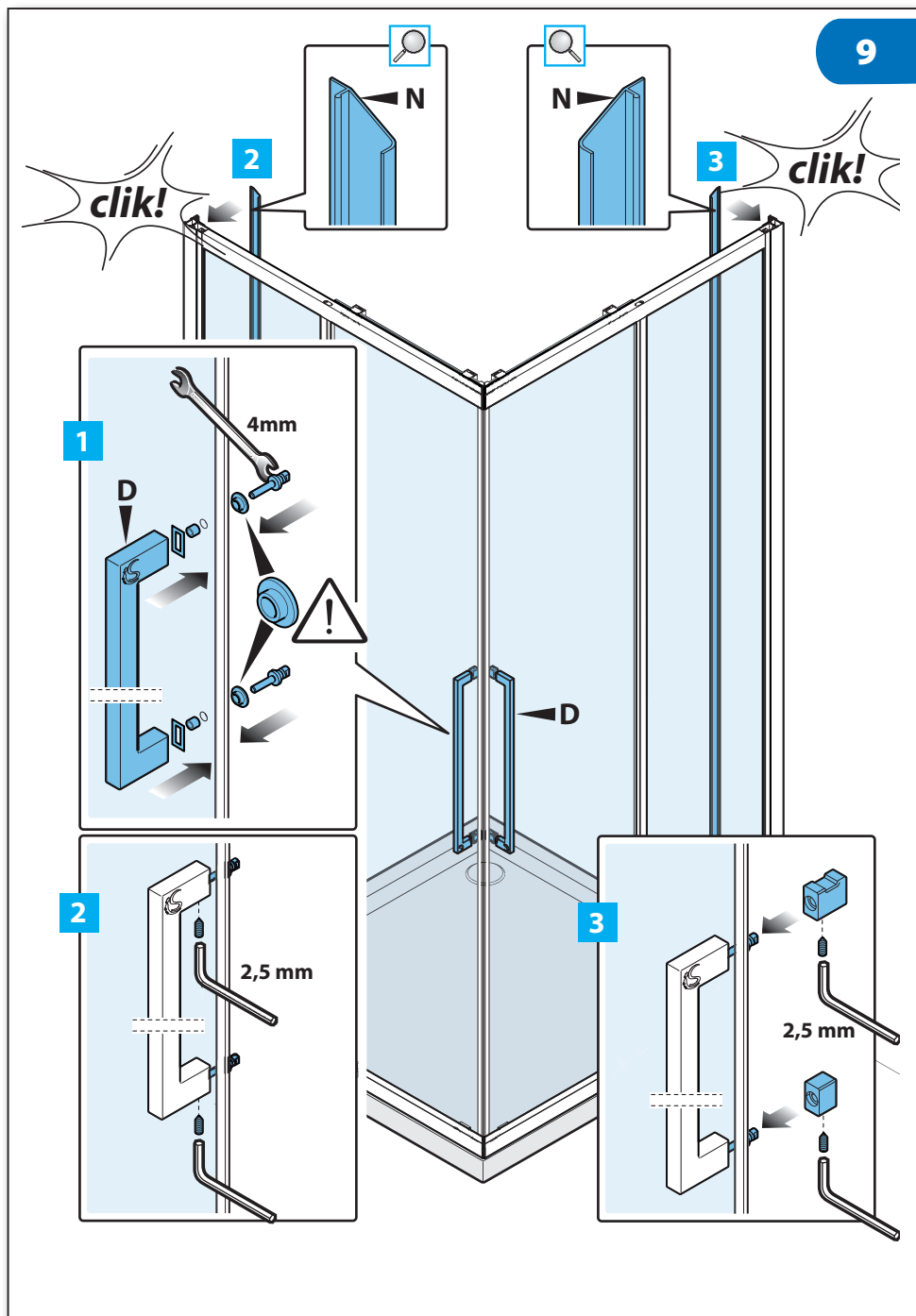

10

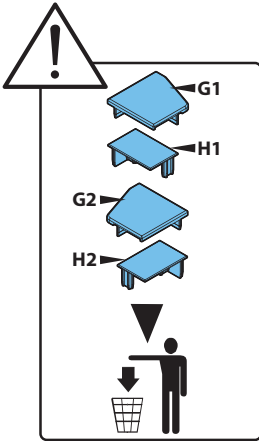
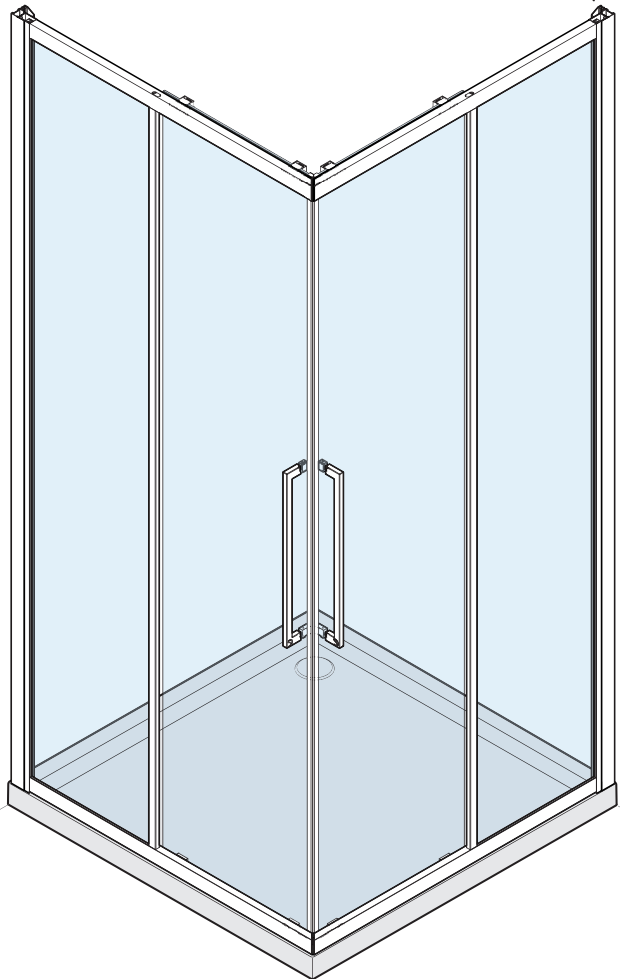
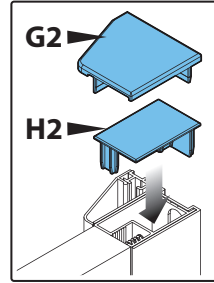
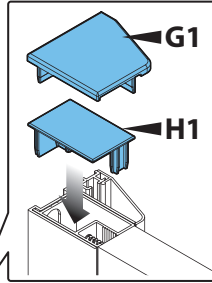



The Bathroom Works
National Avenue
Kingston upon Hull
HU5 4HS England
Telephone: (01482) 346461
Telefax: (01482) 445886.

CUSTOMER CARE HELPLINE

0870 1296085

CUSTOMER CARE FAX LINE 01482 499611

email: ukcustcare@IdealStandard.com

Ideal Standard pursues a policy of continuing improvement in design and performance of its products. The right is, therefore, reserved to vary specifications without notice.

