



# **TONIC “ALCOVE”**

MANUAL FOR USE, INSTALLATION and MAINTENANCE



### Notes on this manual

Partial or total reproduction or copying of this manual without the permission of the manufacturer is prohibited. The contents of this manual are subject to change with no advance notice. Every effort has been made in preparing this manual to ensure the accuracy of its contents. However, if you have any questions or discover any errors, please contact the manufacturer. The manufacturer shall not be held liable for consequences arising from use of the product. The drawings and diagrams contained in the manual are to be considered approximate and are provided only for information



### SALES RULES AND REGULATIONS



The manufacturer recommends carefully reading this booklet

- The manual is provided together with the product and must be kept for future consultation during the entire life of the product and must be transferred to any product owner or installer.
- The product must be installed without any modifications, under penalty of warranty cancellation. The assembly procedures, tools and materials that are indicated must be respected.
- The product was designed and built for installation on a masonry wall: if installed on another type of wall (ex. plasterboard, wood, etc.), the installer is responsible for providing reinforcement to ensure the secure installation of the product.
- For silicon sealing, use acetic silicon.



When installation is complete, remove all packaging items and installation waste according to the current regulations of the country of product use.



### ROUTINE MAINTENANCE OF SHOWER ENCLOSURE AND VISIBLE PARTS

Lime scale and aggressive detergents may make the surface of the shower enclosure opaque over time.

The Manufacturer suggests the following:

Never use powder detergents. Liquid detergents may be used if they are free of alcoholic substances.

Never use products such as ammonia, acetone, alcohol and the like because they may permanently damage the shower enclosure.

After use, your shower should be cleaned with soap and water. This is particularly important in hard water districts where insoluble lime salts may be deposited and allowed to build up.

Cleaners of a gritty or abrasive nature should not be used. Care should be taken to avoid contact with strong chemicals such as organic solvents and strippers.

Glass cleaners can be used but with caution, if in doubt, contact the manufacturer of the cleaner in question.

Please keep these instructions for aftercare and customer service details.

### GUIDE TO INSTRUCTIONS



Installation PHASE



sequence of the OPERATIONS to be performed during a PHASE





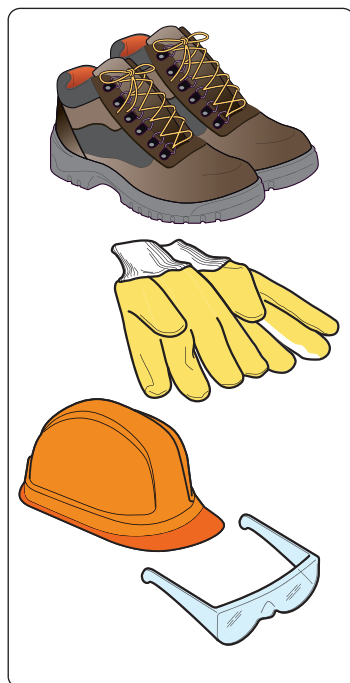
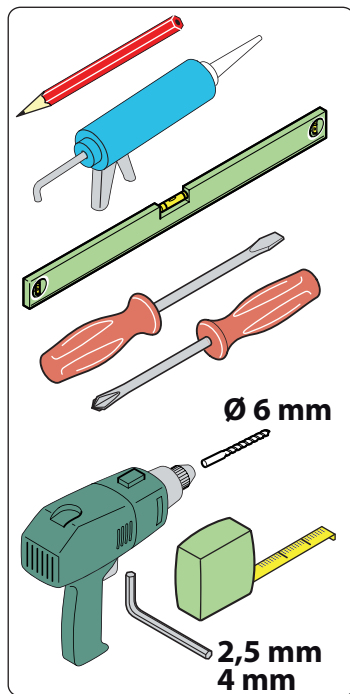
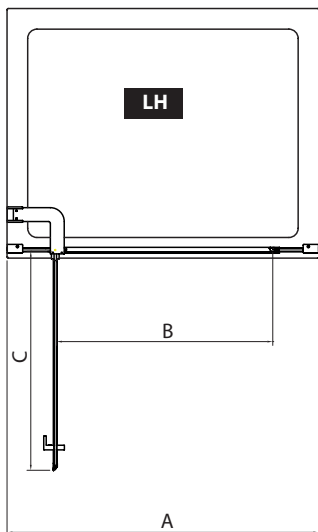
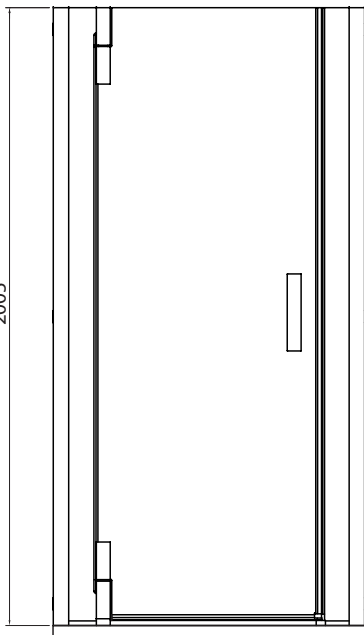





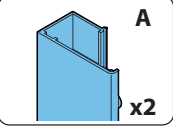
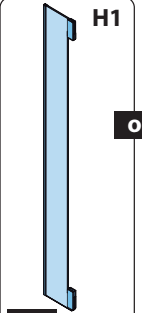
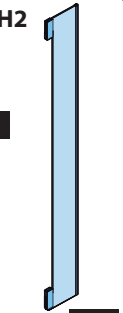
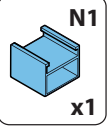
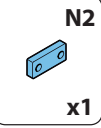
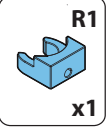

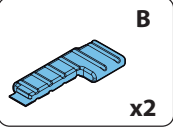
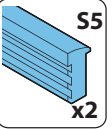
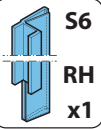
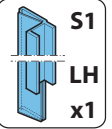
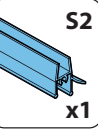
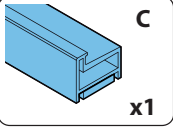
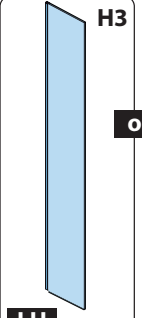
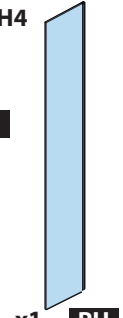
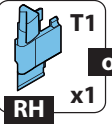
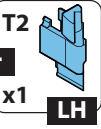
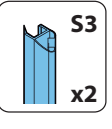
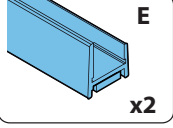
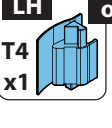
PR2 component identification

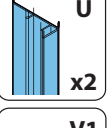
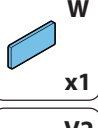
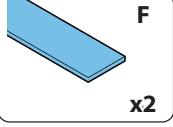
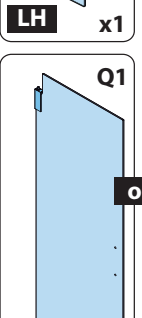
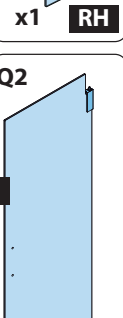
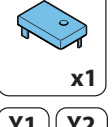
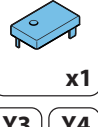
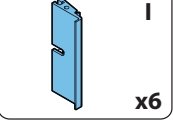
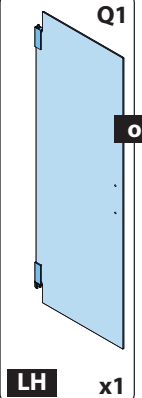
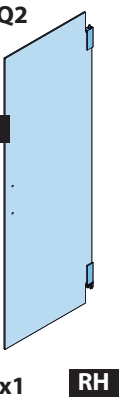
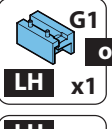
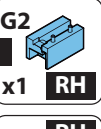
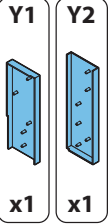
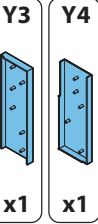
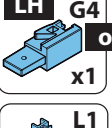
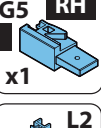
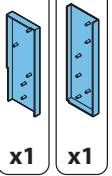
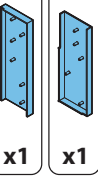
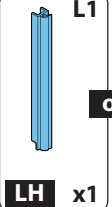
2005

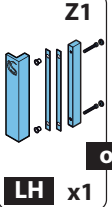
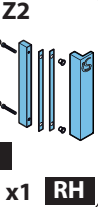
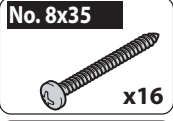
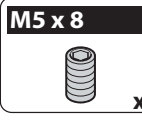
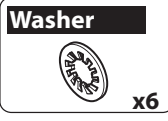

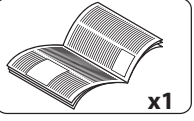
ENCLOSURE	DIM. A WIDTH (mm)	DIM. B OPENING (mm)	DIM. C REACH (mm)	TRAY TYPE
800	770-810	500	510	FT
900	870-910	600	610	FT
1000	970-1010	700	710	FT
800	750-790	480	490	UP
900	850-890	580	590	UP

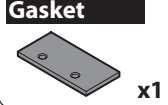
Components

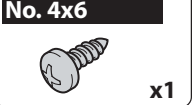
 <b>A</b> x2	 <b>H1</b> <b>LH</b> x1	 <b>H2</b> <b>RH</b> x1	 <b>N1</b> x1	 <b>N2</b> x1	 <b>R1</b> x1	 <b>O</b> x1
 <b>B</b> x2	<b>or</b>		 <b>S5</b> x2	 <b>S6</b> <b>RH</b> x1	 <b>S1</b> <b>LH</b> x1	 <b>S2</b> x1
 <b>C</b> x1	 <b>H3</b> <b>LH</b> x1	 <b>H4</b> <b>RH</b> x1	 <b>T1</b> <b>RH</b> x1	 <b>T2</b> <b>LH</b> x1	 <b>S3</b> x2	
 <b>E</b> x2	<b>or</b>		 <b>T4</b> <b>LH</b> x1	 <b>T5</b> <b>RH</b> x1	 <b>U</b> x2	 <b>W</b> x1
 <b>F</b> x2	 <b>H3</b> <b>LH</b> x1	 <b>H4</b> <b>RH</b> x1	<b>or</b>		 <b>V1</b> x1	 <b>V2</b> x1
 <b>I</b> x6	 <b>Q1</b> <b>LH</b> x1	 <b>Q2</b> <b>RH</b> x1	 <b>G1</b> <b>LH</b> x1	 <b>G2</b> <b>RH</b> x1	 <b>Y1</b> x1	 <b>Y2</b> x1
	<b>or</b>		 <b>G4</b> <b>LH</b> x1	 <b>G5</b> <b>RH</b> x1	 <b>Y3</b> x1	 <b>Y4</b> x1
	 <b>L1</b> <b>LH</b> x1	 <b>L2</b> <b>RH</b> x1	<b>or</b>		 <b>Z1</b> <b>LH</b> x1	 <b>Z2</b> <b>RH</b> x1
 <b>No. 8x35</b> x16	 <b>M5 x 8</b> x2	 <b>Washer</b> x6	 <b>No. 3,5x15</b> x3	 x1		
 <b>4,5x12</b> x6	 <b>Gasket</b> x1	 <b>M4 x 15</b> x2	 <b>No. 4x6</b> x1			

1



**ATTENTION!**

- Ensure tray is level and firm
- Tray **MUST** be sealed before enclosure installation begins
- It is recommended that shower enclosures are fitted onto a tiled wall surface.
- Wall fixing supplied are for solid wall construction
- Substitute suitable fixing as appropriate

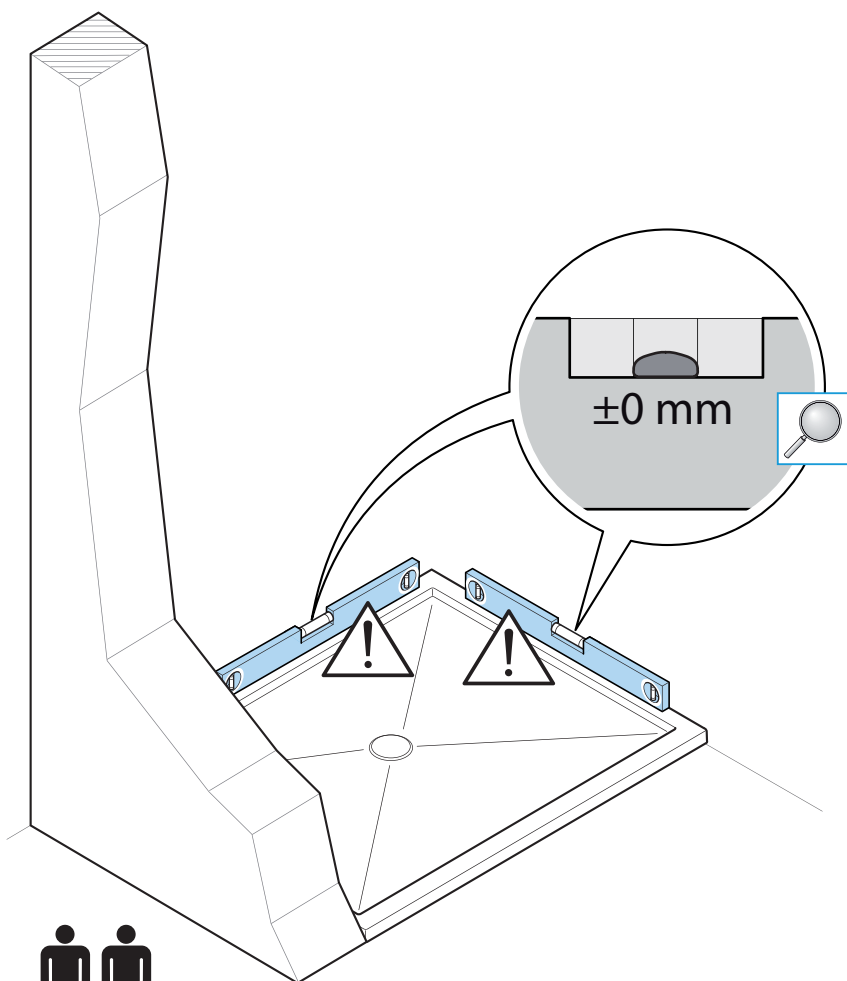

**This product is heavy and may require two people to install**

2

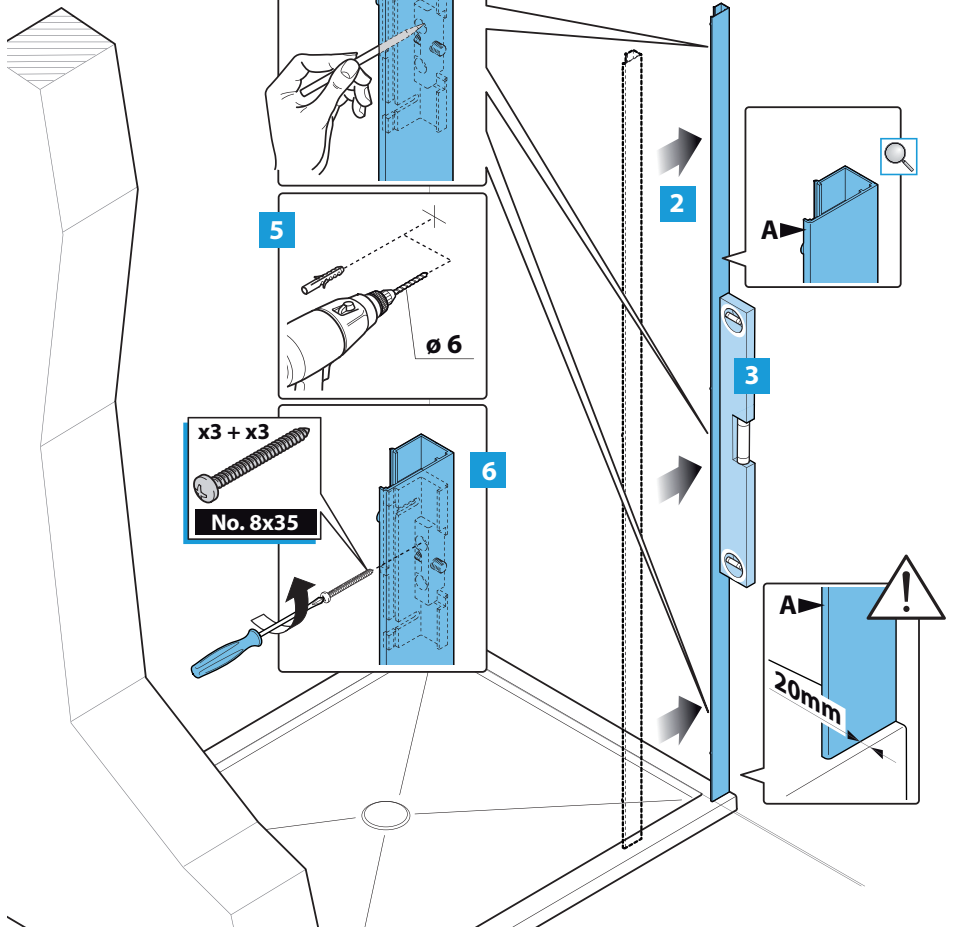
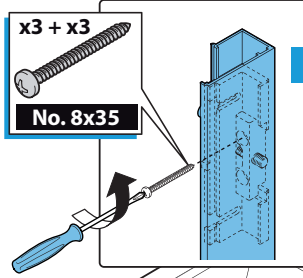
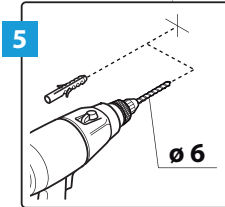
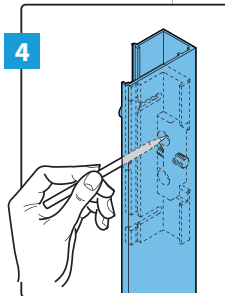
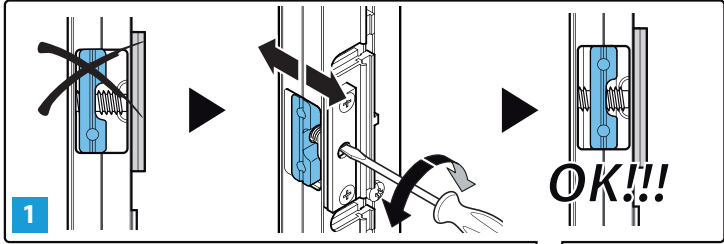

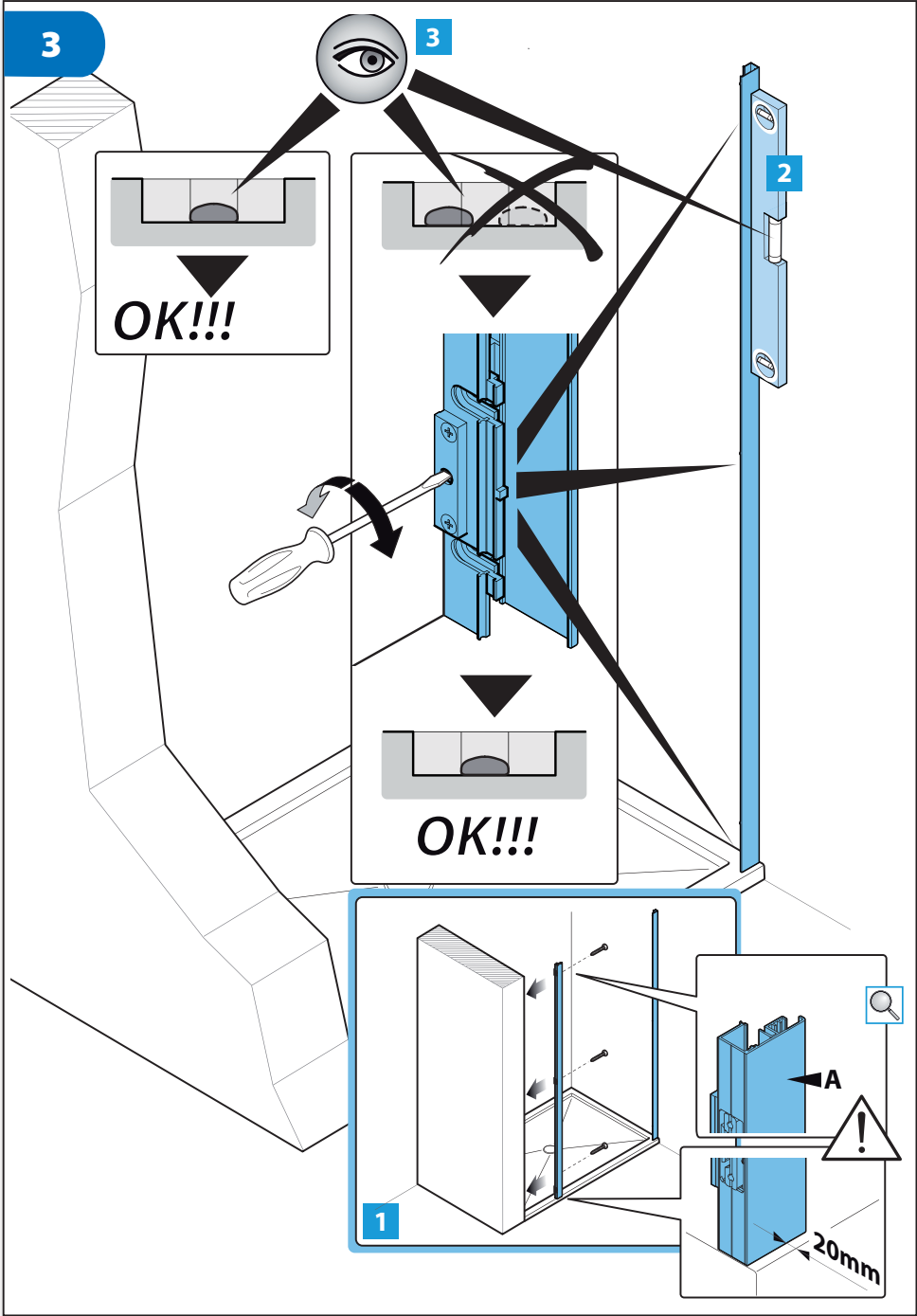



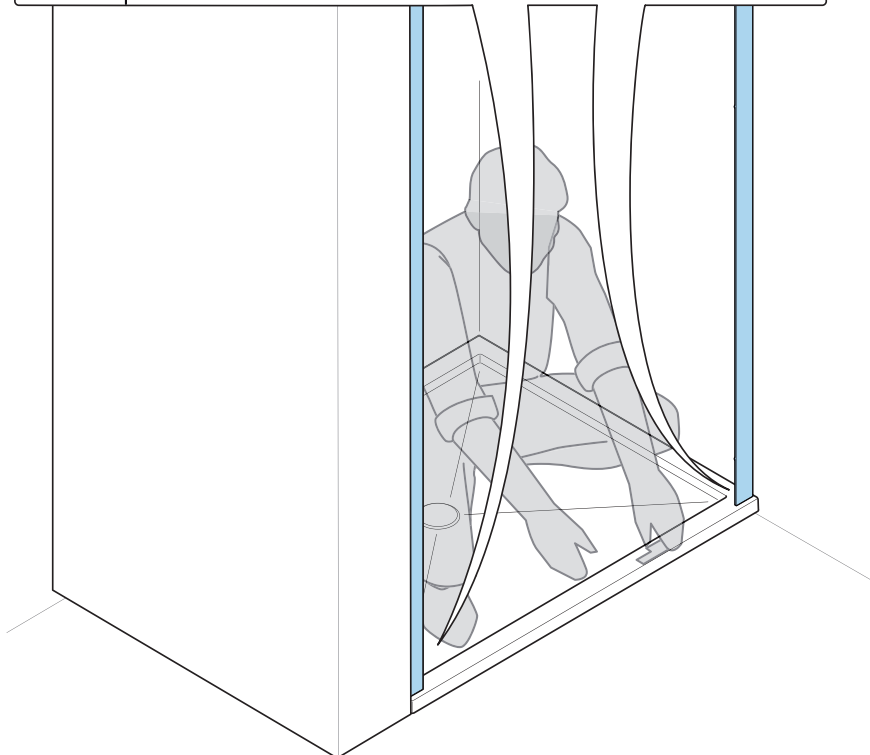
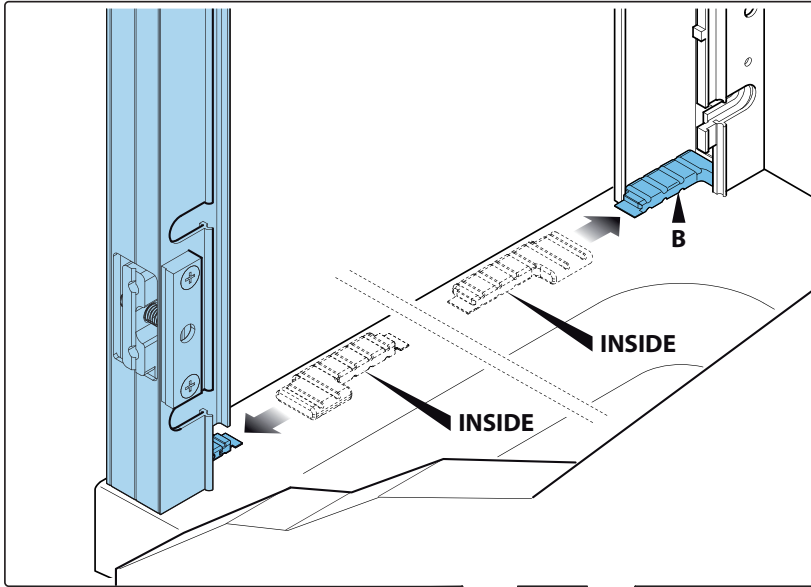

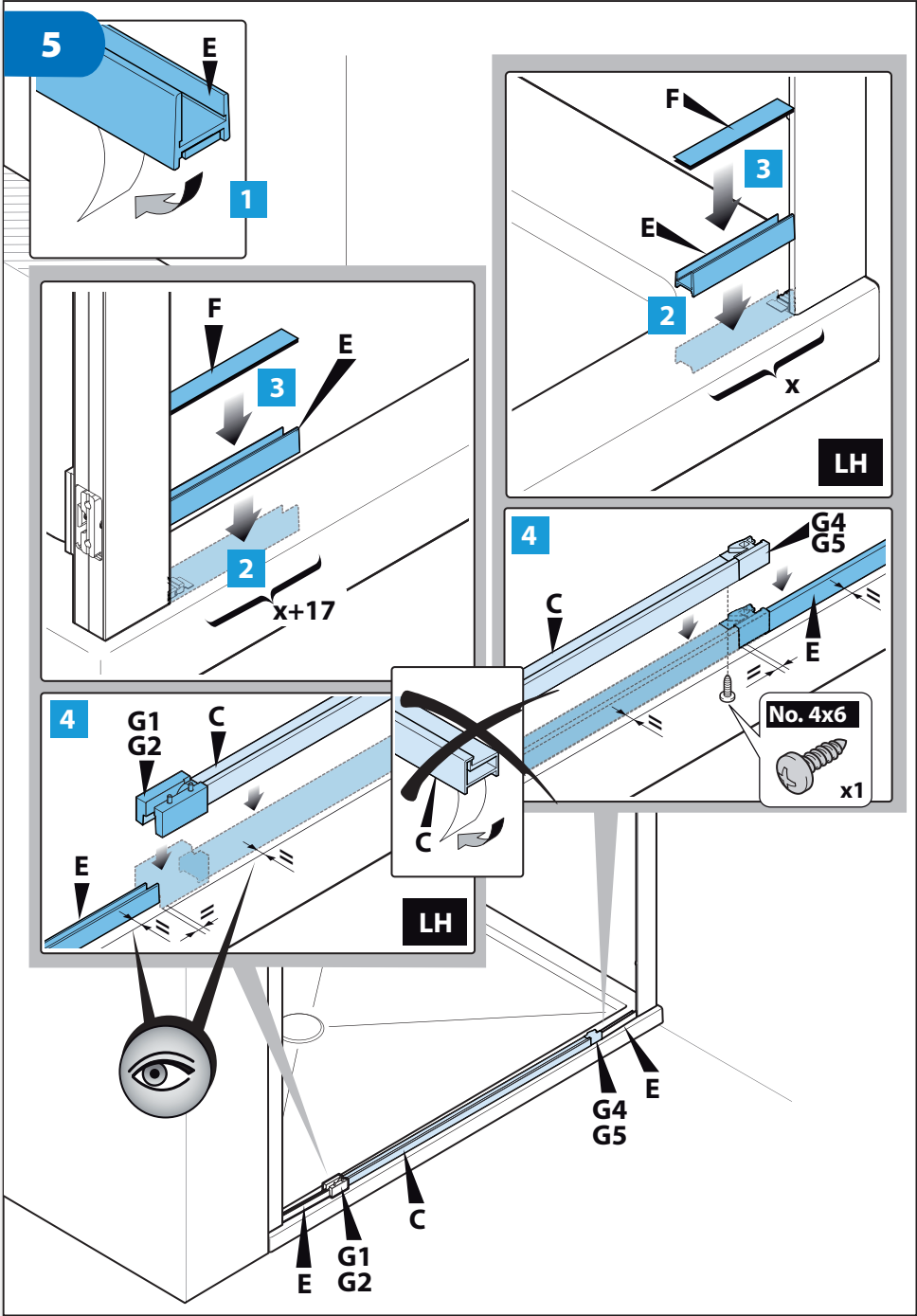

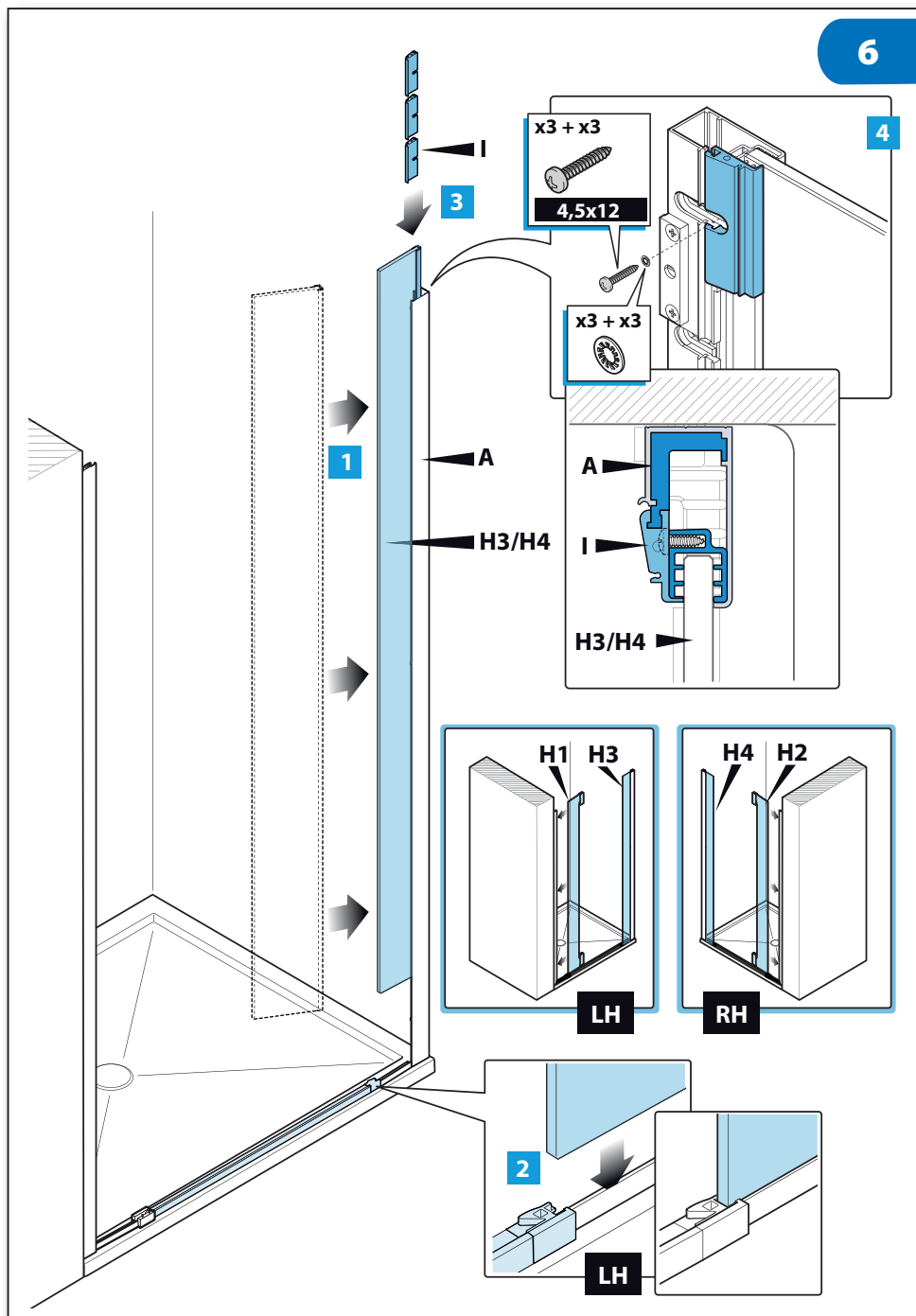

7

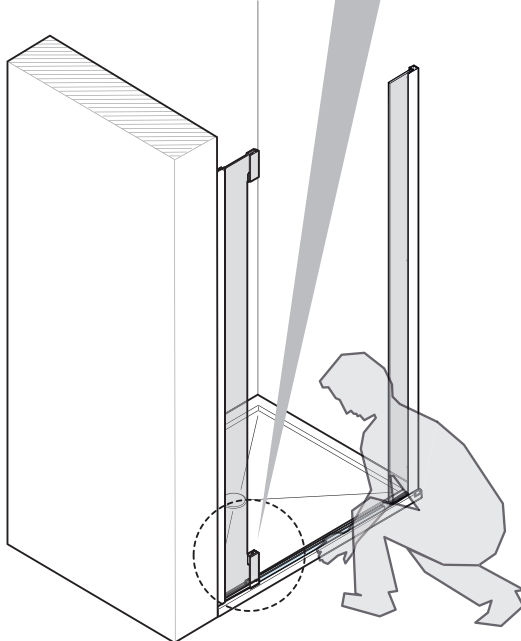
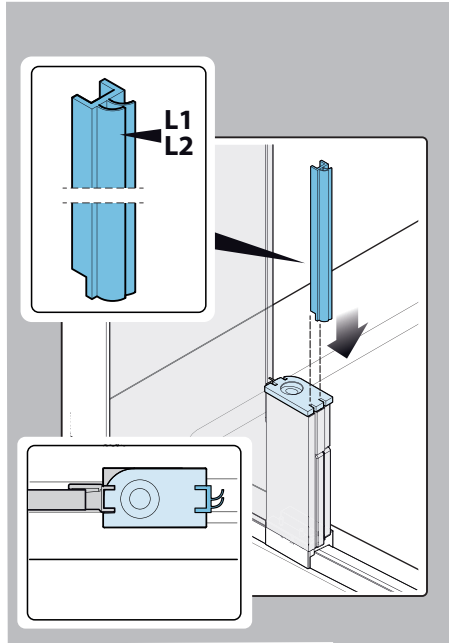

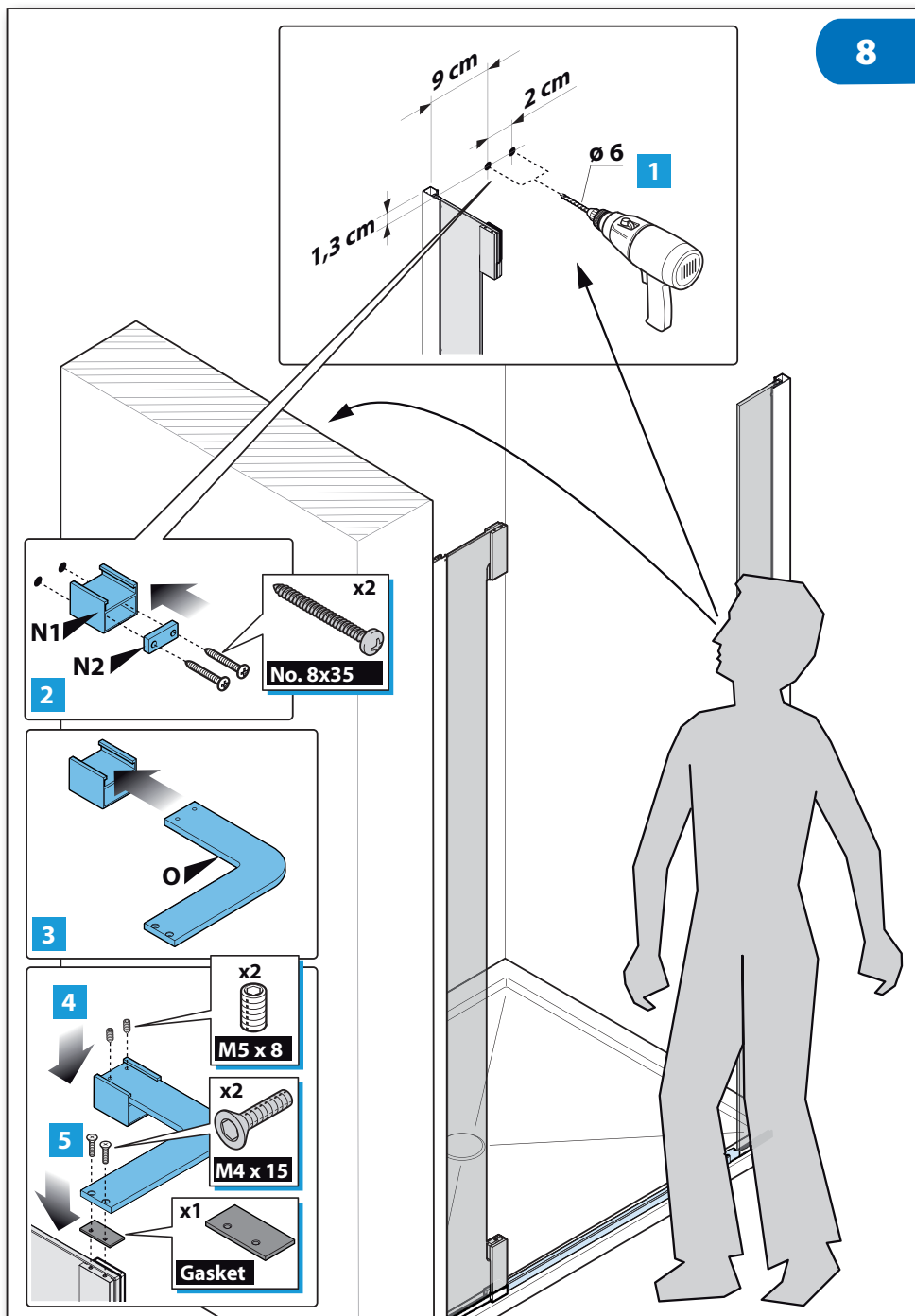

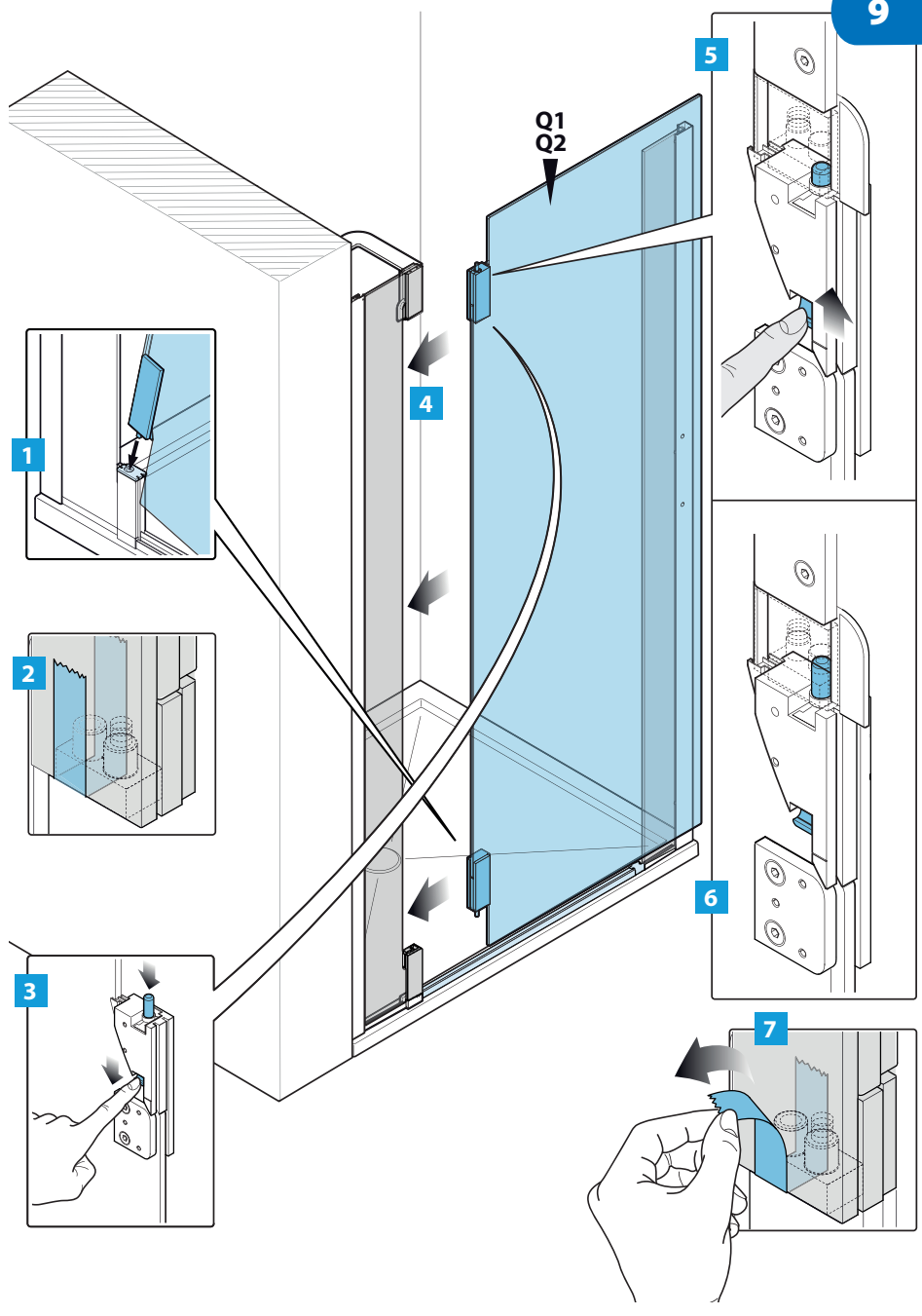

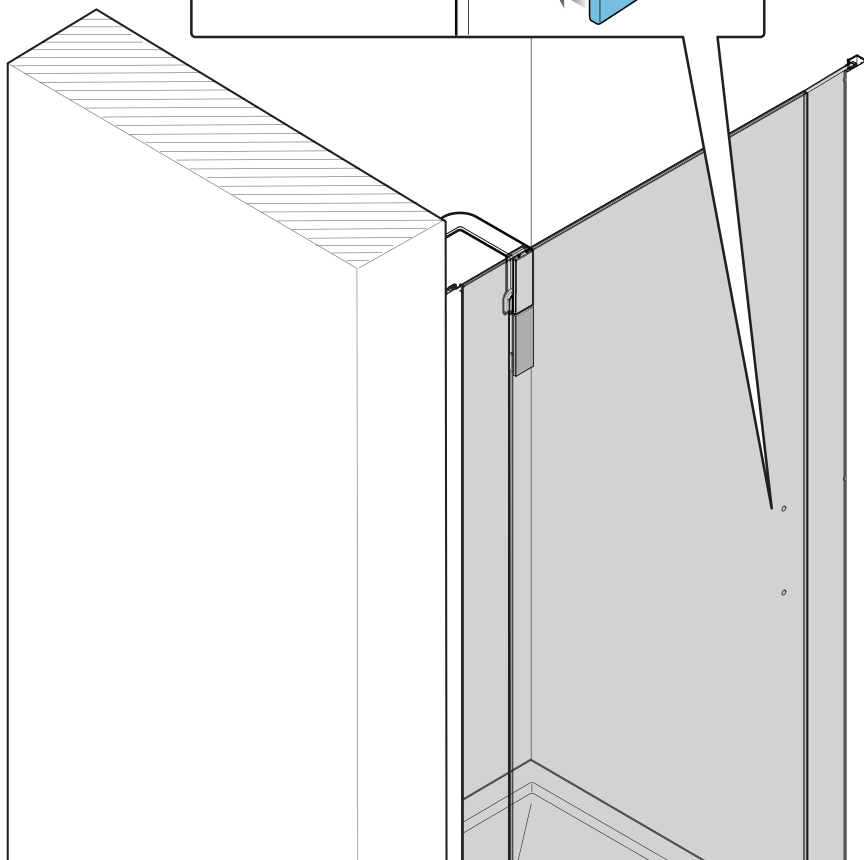
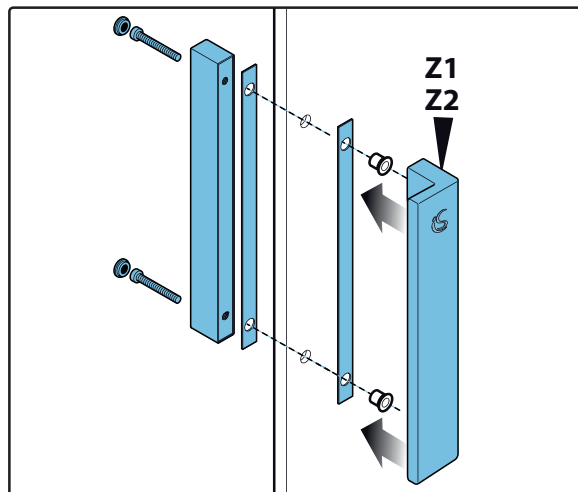

11

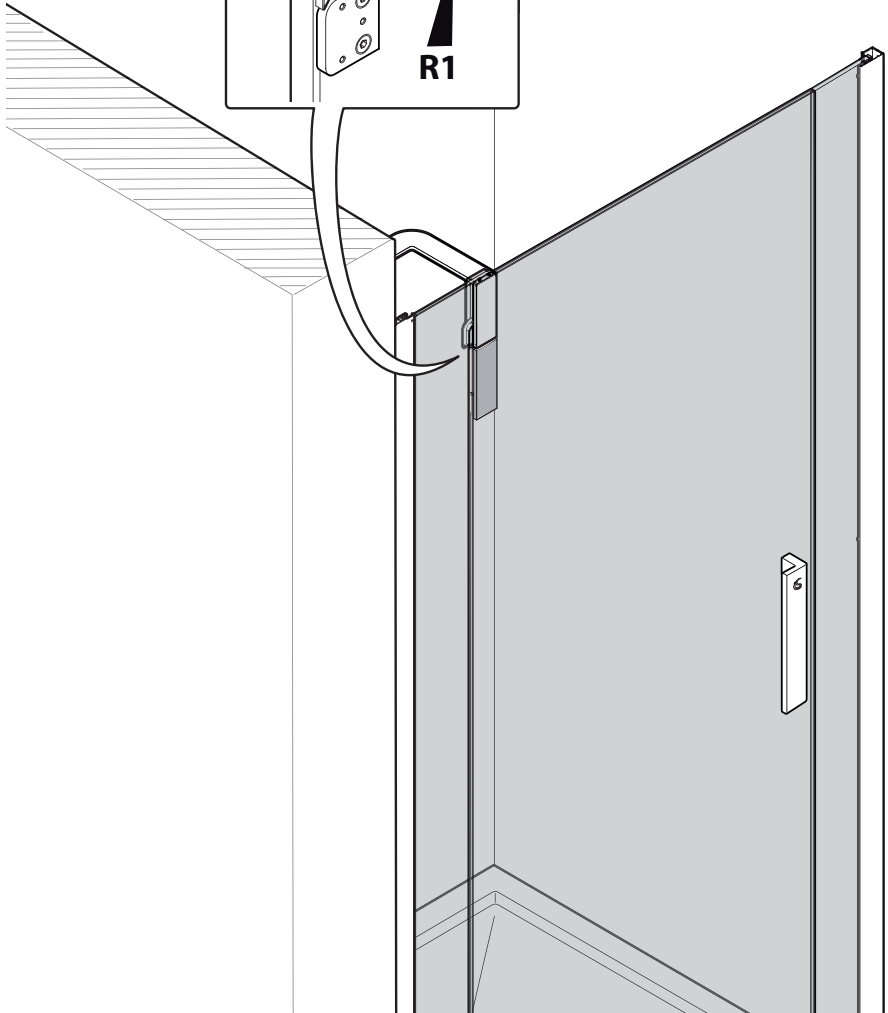
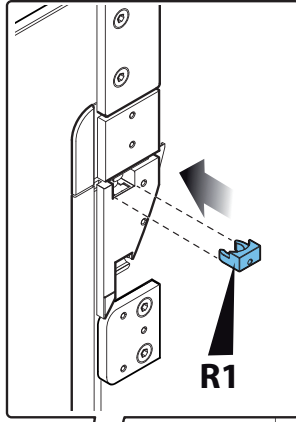



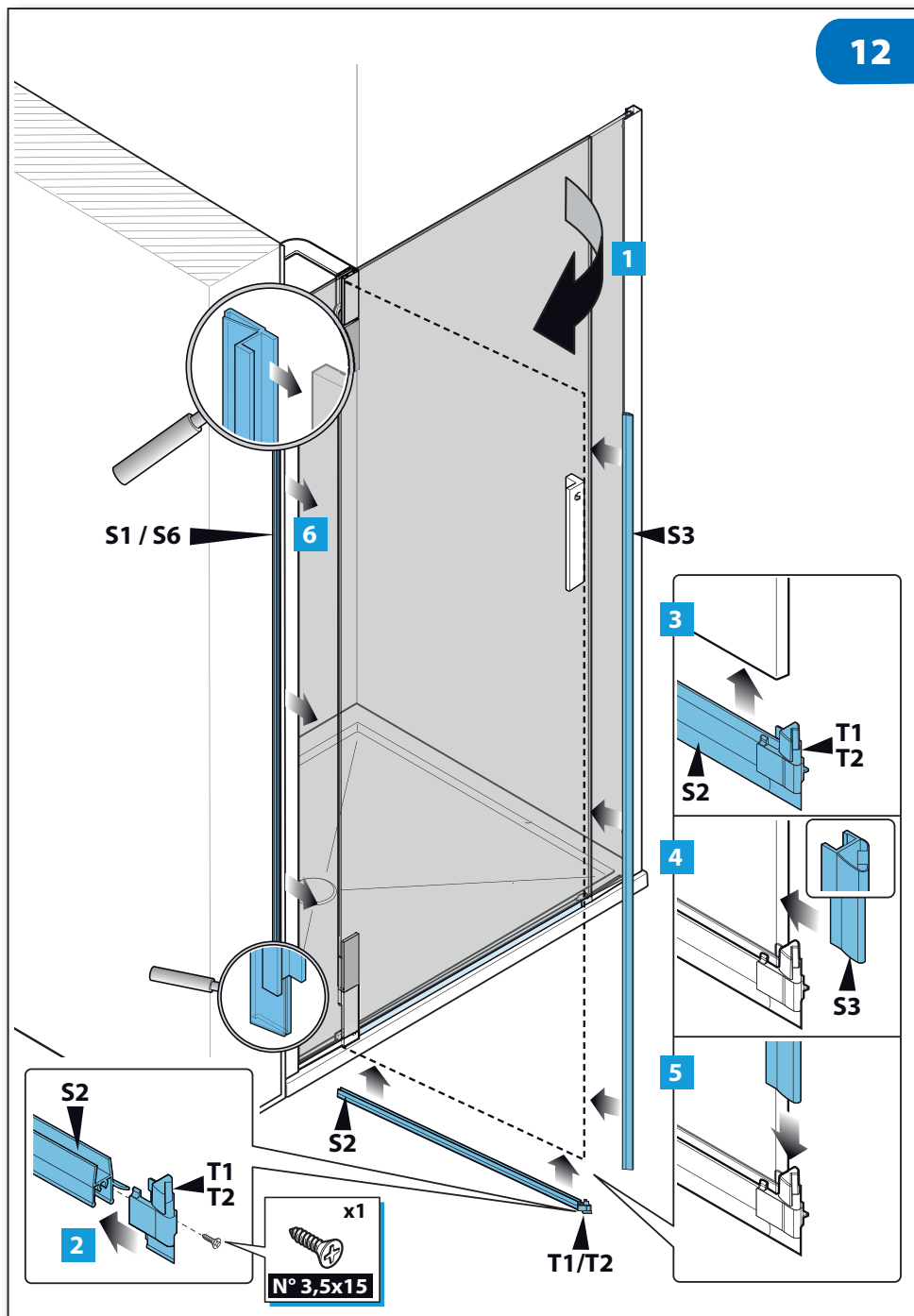

13

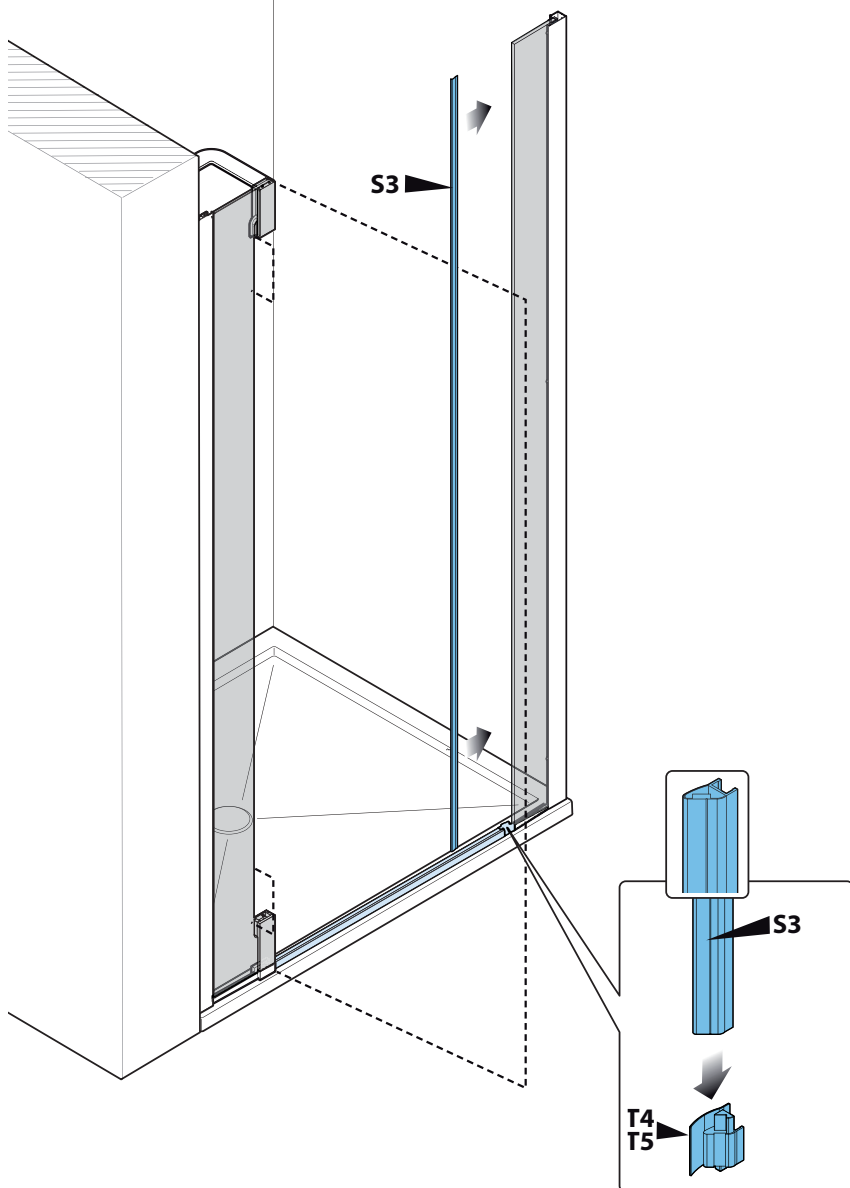

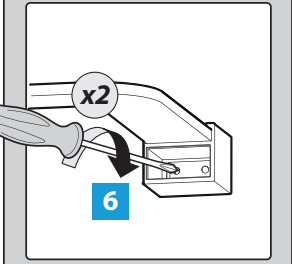
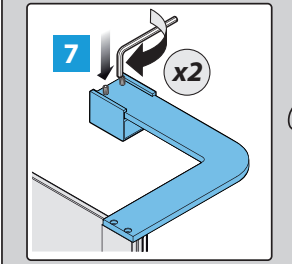
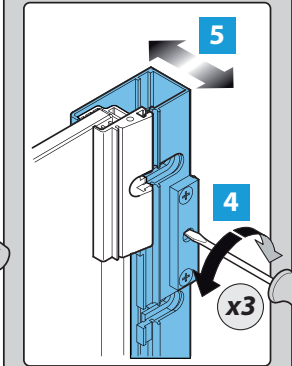
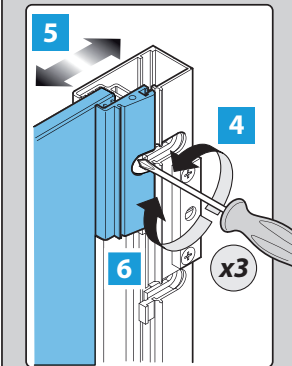
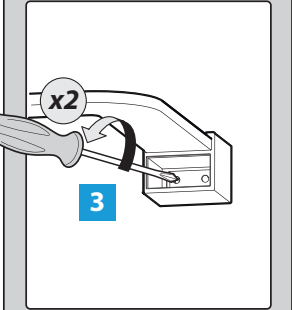
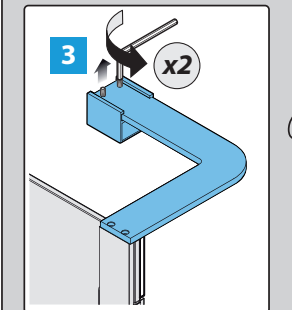
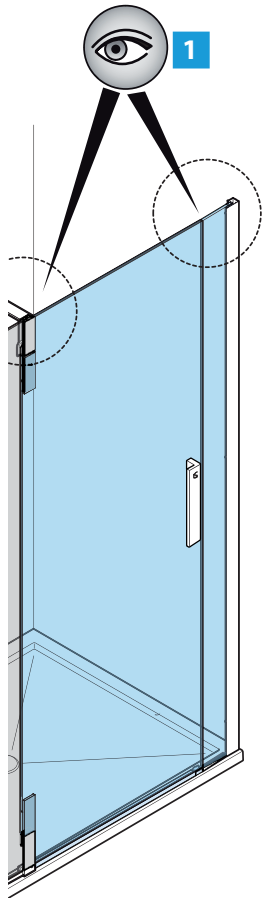
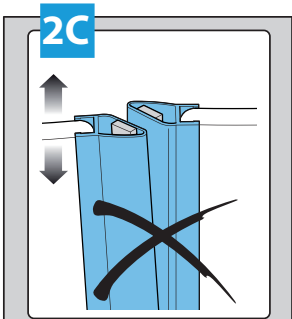
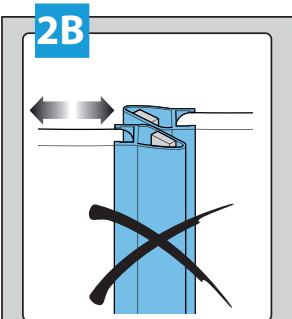
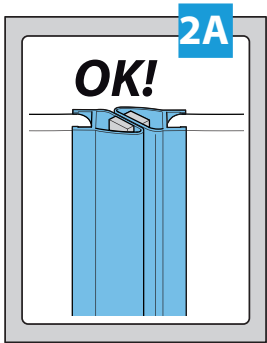



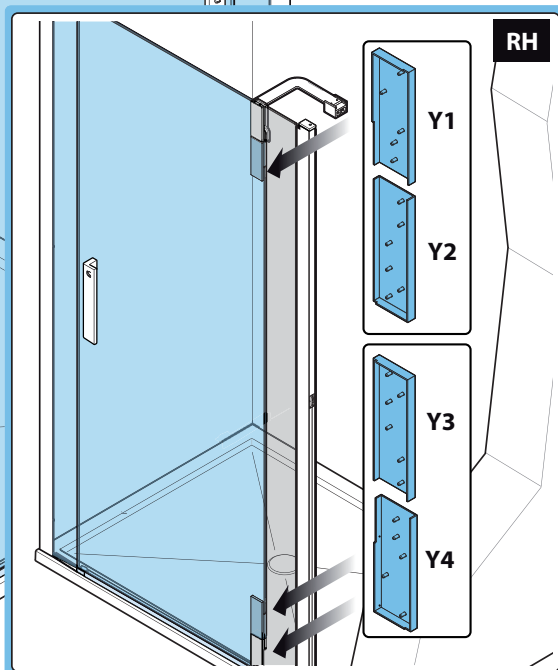
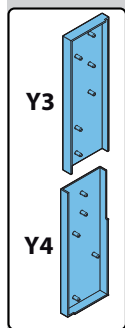
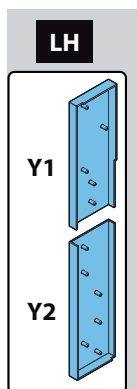
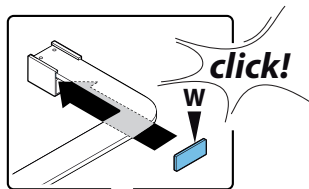

17

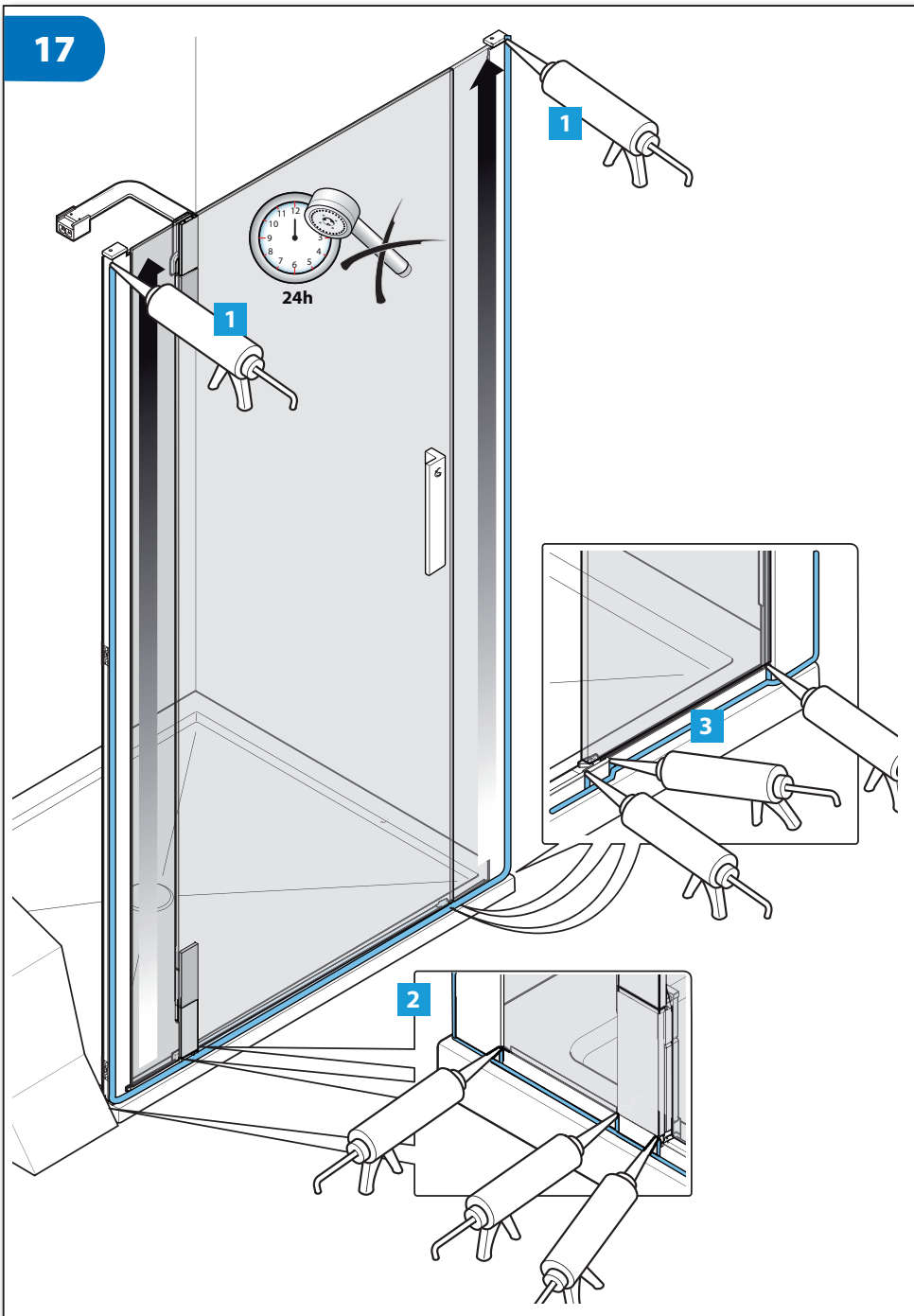





The Bathroom Works  
National Avenue  
Kingston upon Hull  
HU5 4HS England  
Telephone: (01482) 346461  
Telefax: (01482) 445886.

**CUSTOMER CARE HELPLINE**  
**0870 1296085**  
**CUSTOMER CARE FAX LINE 01482 499611**  
**email: [ukcustcare@IdealStandard.com](mailto:ukcustcare@IdealStandard.com)**

Ideal Standard pursues a policy of continuing improvement in design and performance of its products.  
The right is, therefore, reserved to vary specifications without notice.