

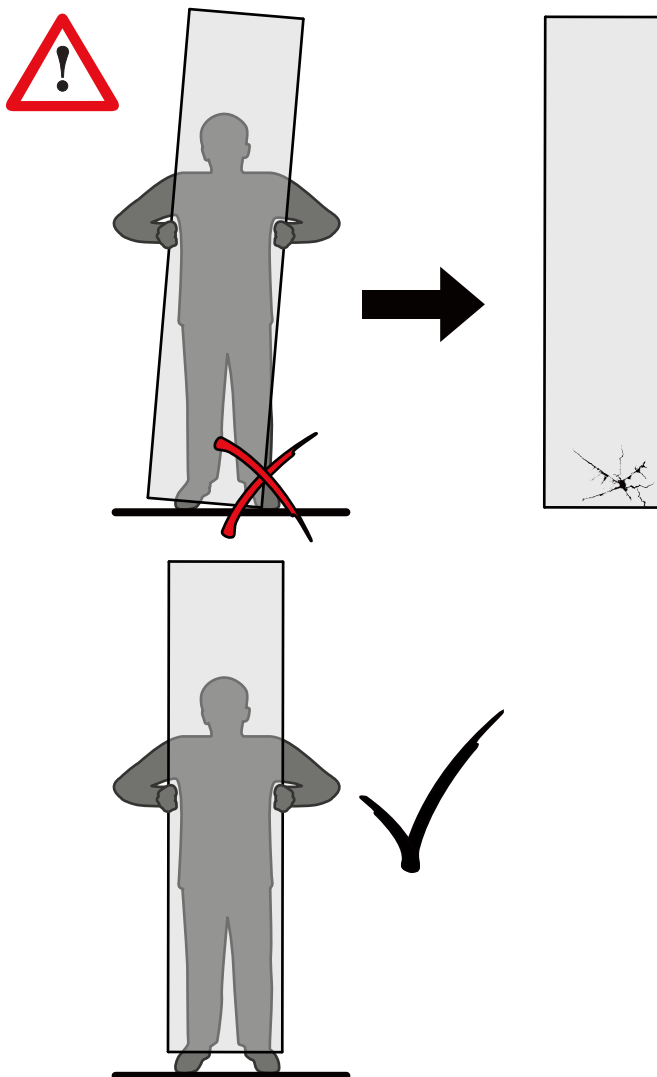

CONNECT 2 CORNER ENTRY *UK version*

MANUAL FOR USE, INSTALLATION and MAINTENANCE

- IT** - EVITARE L'IMPATTO CON GLI ANGOLI DELLA PARETE VETRATA. QUESTO PUÒ PROVOCARNE LA FRAMMENTAZIONE IMMEDIATA O IN UN MOMENTO SUCCESSIVO
- UK** - AVOID IMPACT WITH THE CORNERS OF THE GLASS THIS MAY CAUSE IMMEDIATE OR DELAYED SHATTERING
- FR** - EVITER TOUT CHOC SUR LES ANGLES DE LA PAROI - CELA POURRAIT ENTRAÎNER UN BRIS DE GLACE INSTANTANÉ OU DIFFÉRÉ DANS LE TEMPS
- DE** - ANSTOßEN BILDSCHIRMS VERMEIDEN, DA DIES ZU UNMITTELBARER ODER SPÄTERER BESCHÄDIGUNG FÜHREN KANN
- ES** - EVITAR GOLPES EN LOS CANTOS. ESTOS GOLPES PODRÍAN CAUSAR ROTURAS INMEDIATAS O CON EFECTO POSTERIOR
- NL** - VERMIJD IEDER CONTACT MET DE HOEKEN VAN HET GLAZEN PANEEL, DIT KAN DIRECT OF NA VERLOOP VAN TIJD TOT BESCHADIGING LEIDEN
- GR** - ΑΠΟΦΥΓΕΤΕ ΧΤΥΠΗΜΑΤΑ ΣΤΙΣ ΓΩΝΙΕΣ ΤΟΥ ΓΥΑΛΙΟΥ, ΑΥΤΟ ΜΠΟΡΕΙ ΝΑ ΠΡΟΚΑΛΕΣΕΙ ΘΡΥΜΜΑΤΙΣΜΟ ΑΜΕΣΑ Η ΑΡΓΟΤΕΡΑ
- РУС** - ИЗБЕГАЙТЕ УДАРОВ С УГЛАМИ ЭКРАНА, ЭТО МОЖЕТ СТАТЬ ПРИЧИНОЙ НЕМЕДЛЕННОГО ИЛИ ОТЛОЖЕННОГО ОБРАЗОВАНИЯ ТРЕЩИН
- CZ** - VYVARUJTE SE NÁRAZU ROHŮ SKLA NA TVRDÝ POVRCH – MŮŽE DOJÍT K OKAMŽITÉMU NEBO POZDĚJŠÍMU ROZTRÍŠTĚNÍ SKLA
- SK** - VYVARUJTE SA NÁRAZU ROHOV SKLA NA TVRDÝ POVRCH - MÔŽE DÔJSŤ K OKAMŽITÉMU ALEBO NESKORŠIEMU ROZTRIEŠTENIE SKLA
- SLO** - IZOGNITE SE UDARCEV NA ROBOVIH, KER STEKLO SE LAHKO TAKOJ ALI NAKNADNO RAZBIE
- HR** - IZBJEGAVAJTE UDARCE KUTEVIMA STAKLENOG ZASLONA JER MOGU UZROKOVATI TRENUTACNI LOM ILI NAKNADNA PUKNUCA
- BG** - ДА СЕ ИЗБЯГВАТ УДАРИ В ЪГЛИТЕ НА СЪЪКЛОТО, ЗАЩОТО ТОВА МОЖЕ ДА ДОВЕДЕ ДО НЕЗАБАВНО ИЛИ ОТЛОЖЕНО ВЪВ ВРЕМЕТО НАПУКВАНЕ



Notes on this manual

Partial or total reproduction or copying of this manual without the permission of the manufacturer is prohibited. The contents of this manual are subject to change with no advance notice. Every effort has been made in preparing this manual to ensure the accuracy of its contents. However, if you have any questions or discover any errors, please contact the manufacturer. The manufacturer shall not be held liable for consequences arising from use of the product. The drawings and diagrams contained in the manual are to be considered approximate and are provided only for information



SALES RULES AND REGULATIONS



The manufacture recommends carefully reading this booklet

- The manual is provided together with the product and must be kept for future consultation during the entire life of the product and must be transferred to any product owner or installer.
- The product must be installed without many any modifications, under penalty of warranty cancellation. The assembly procedures, tools and materials that are indicated must be respected.
- The product was designed and built for installation on a masonry wall; if installed on another type of wall (ex. plasterboard, wood, etc.), the installer is responsible for providing reinforcement to ensure the secure installation of the product.
- For silicon sealing, use acetic silicon.



When installation is complete, remove all packaging items and installation waste according to the current regulations of the country of product use.



ROUTINE MAINTENANCE OF SHOWER ENCLOSURE AND VISIBLE PARTS

Lime scale and aggressive detergents may make the surface of the shower enclosure opaque over time.

The Manufacturer suggests the following:

Never use powder detergents. Liquid detergents may be used if they are free of alcoholic substances.

Never use products such as ammonia, acetone, alcohol and the like because they may permanently damage the shower enclosure.

After use, your shower should be cleaned with soap and water. This is particularly important in hard water districts where insoluble lime salts may be deposited and allowed to build up.

Cleaners of a gritty or abrasive nature should not be used. Care should be taken to avoid contact with strong chemicals such as organic solvents and strippers.

Glass cleaners can be used but with caution, if in doubt, contact the manufacturer of the cleaner in question.

Please keep these instructions for aftercare and customer service details.

GUIDE TO INSTRUCTIONS

1

Installation PHASE

1

2

sequence of the OPERATIONS to be performed during a PHASE

PR2

component identification

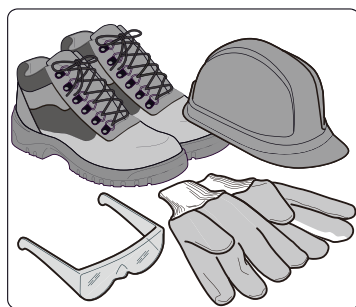
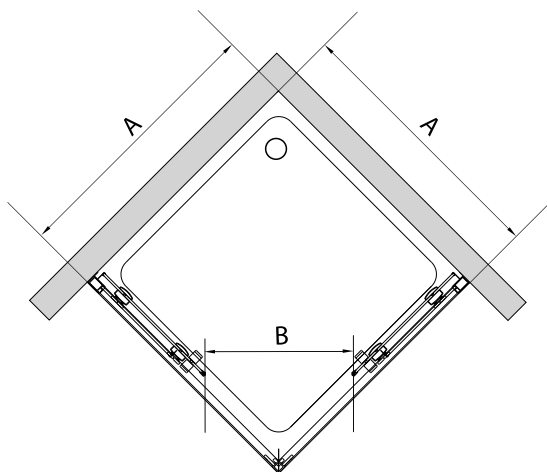
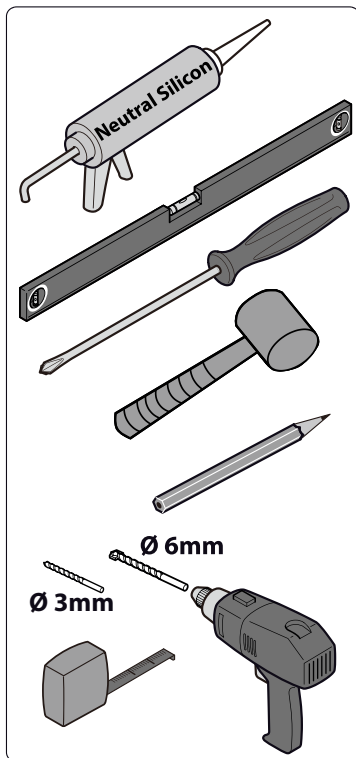
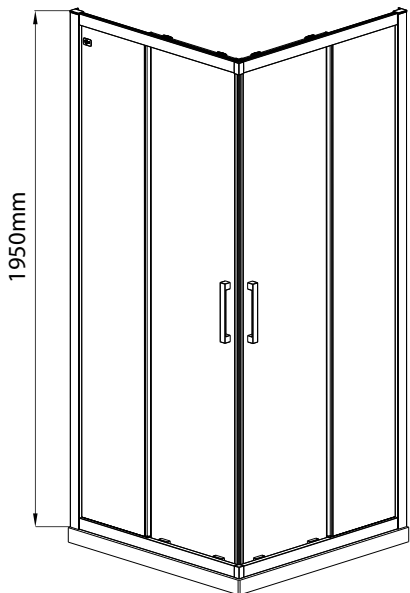

	A(mm)	B(mm)
CORNER ENTRY 800	755-780	415
CORNER ENTRY 900	855-880	485



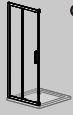

Components

A

B1



x1

I4

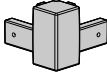

x1

A1



x1

A3



x1

I1

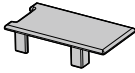

x1

I2

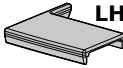

x1

I3



x1

RH

C1

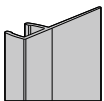

1866mm

x1

D

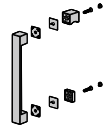

x1

C2

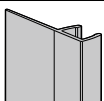

1927mm

x1

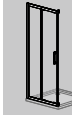

Components

B

B1



x1

I4

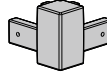

x1

A2

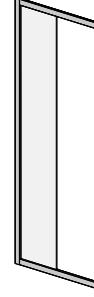

x1

A4



x1

I1

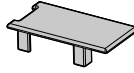

x1

I2

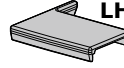

x1

I3



x1

RH

C1

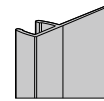

1866mm

x1

D

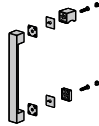

x1

C2

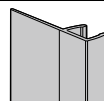

1927mm

x1



E1

TCB 3,9x30



x3

F



x3

E2

TCB 3,9x9



x5

G



x8

H



x8

E1

TCB 3,9x30

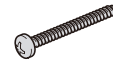

x3

F



x3

E2

TCB 3,9x9



x5

G



x8

H



x8

K



x1

J



x1

K



x1

J



x1

1



ATTENTION!

- Ensure tray is level and firm
- Tray **MUST** be sealed before enclosure installation begins
- It is recommended that shower enclosures are fitted onto a tiled wall surface.
- Wall fixing supplied are for solid wall construction
- Substitute suitable fixing as appropriate

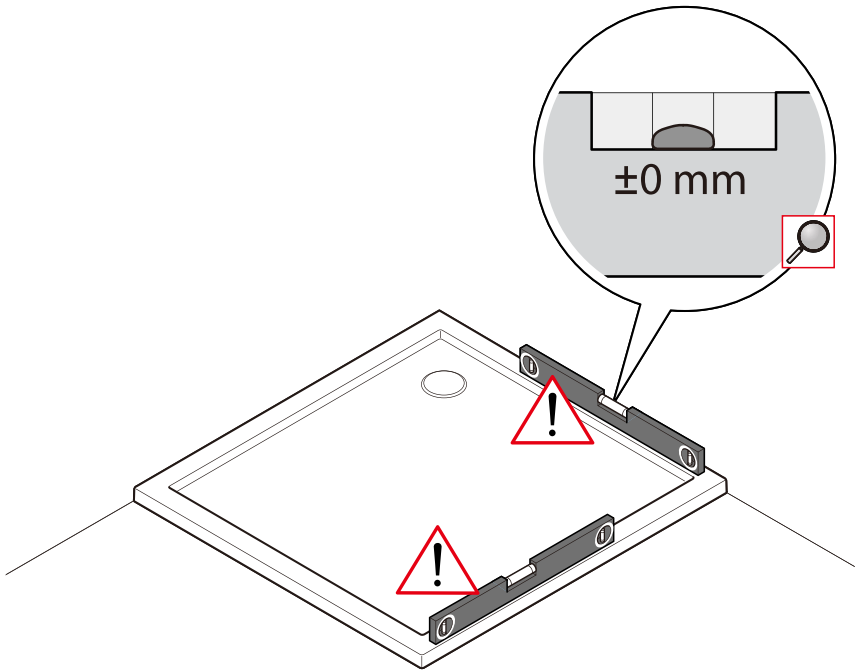

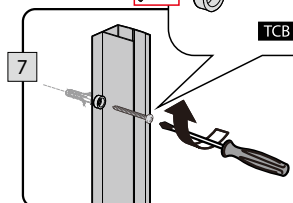
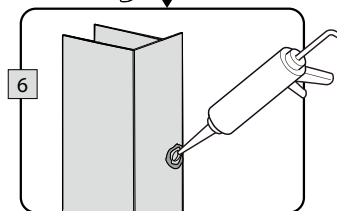
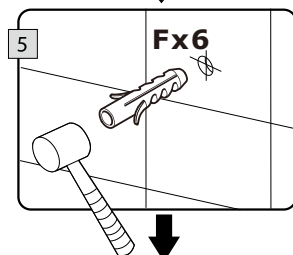
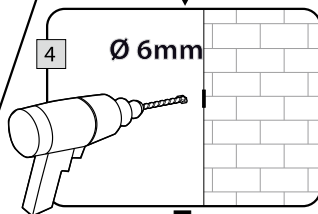
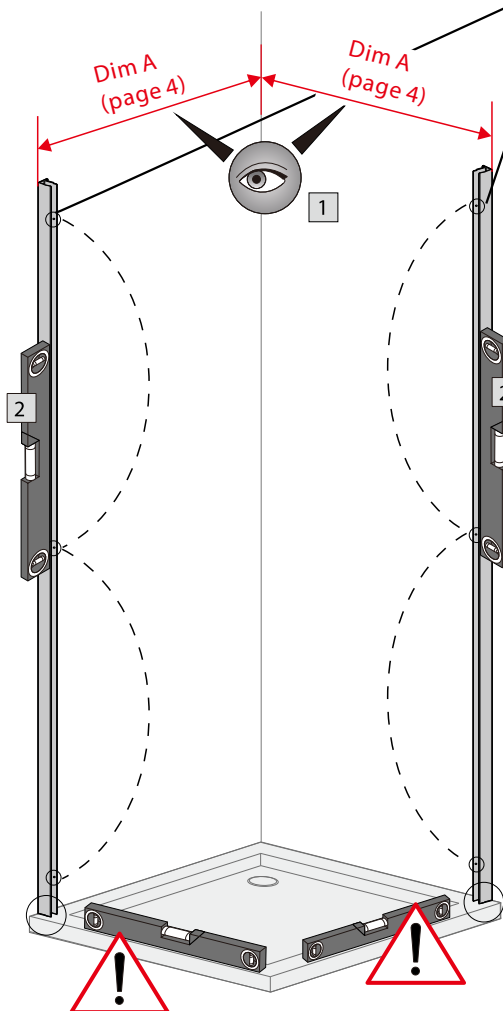
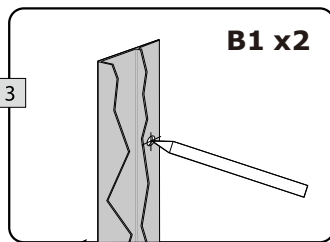
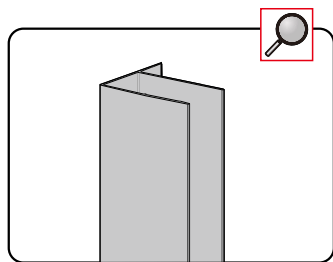

3

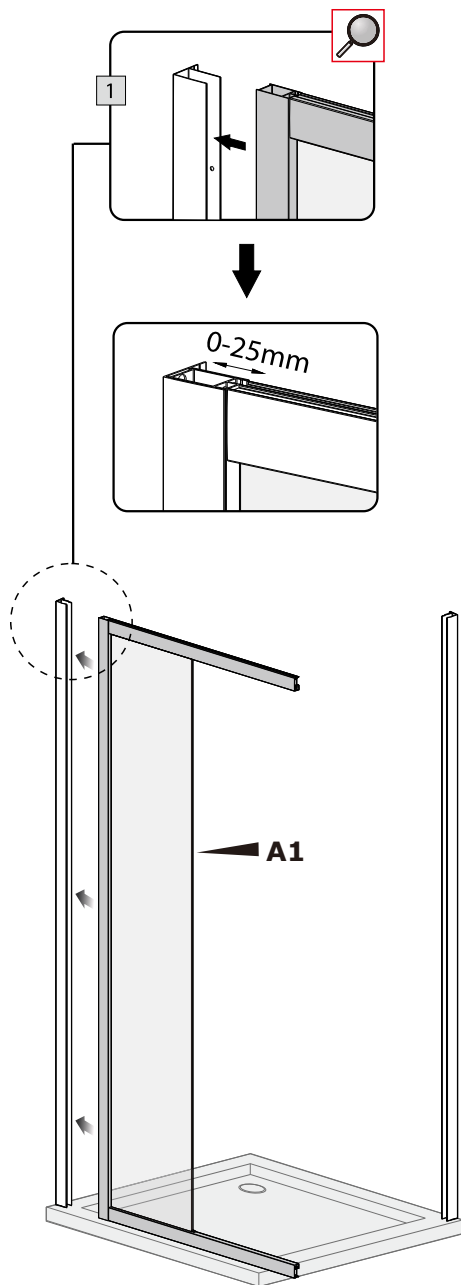

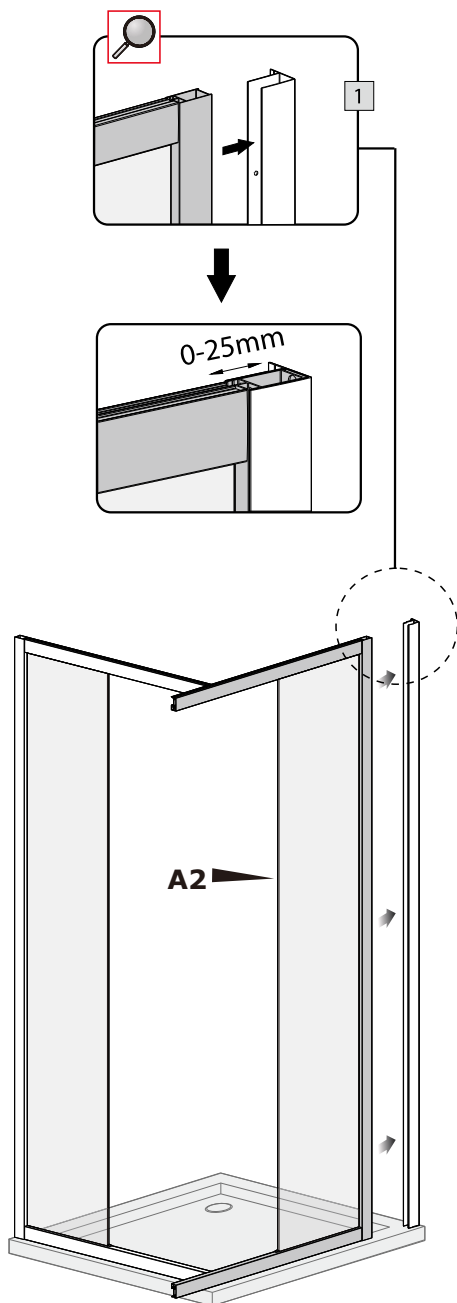

5

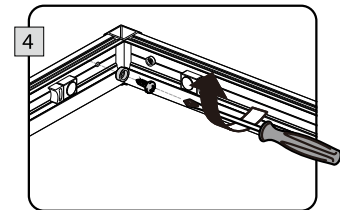
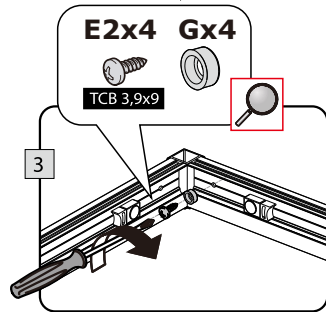
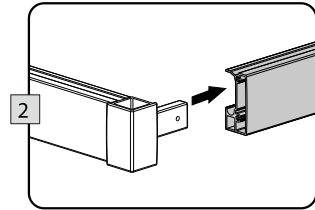
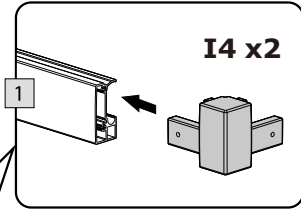
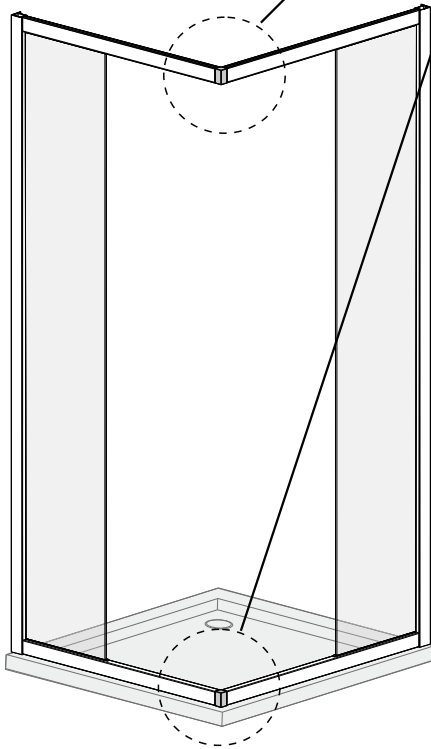

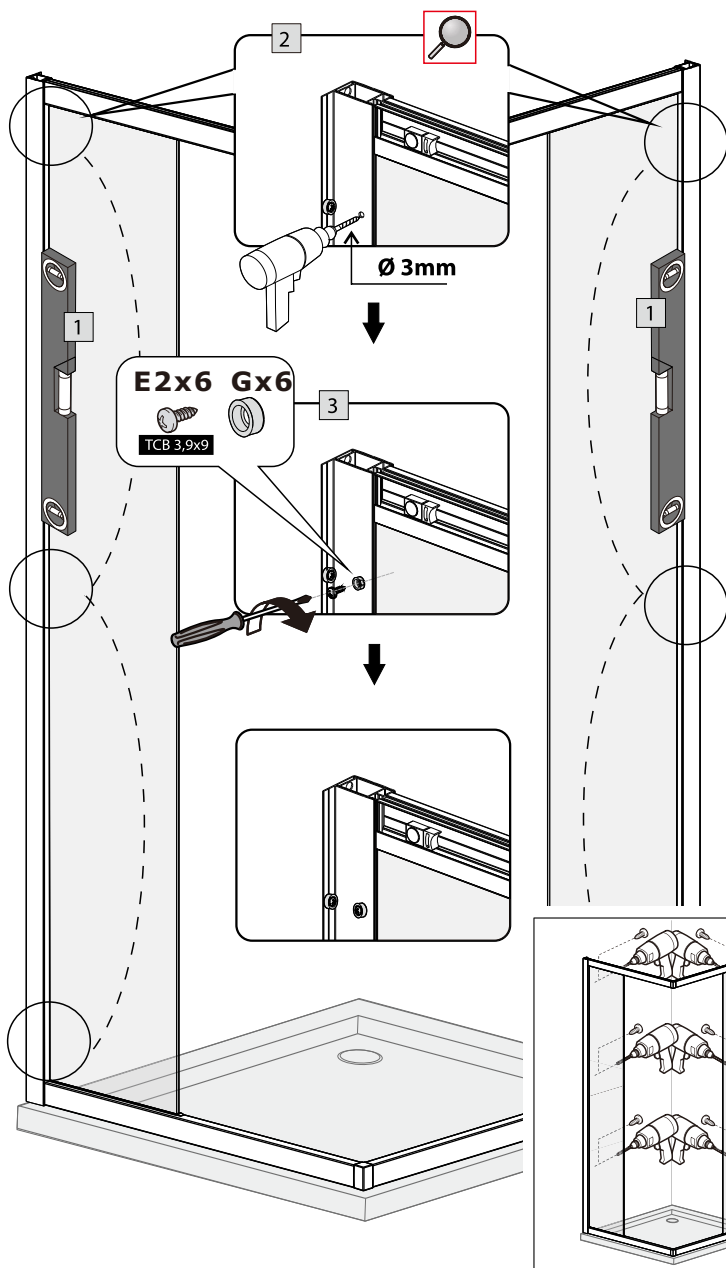

7

C1x2

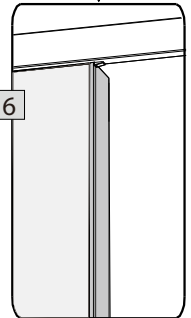
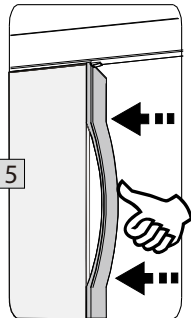
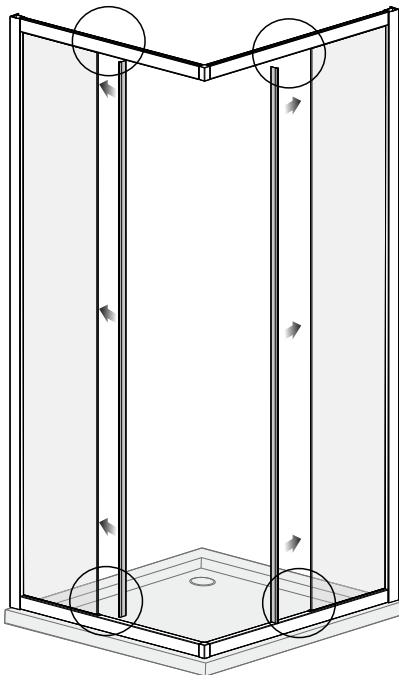
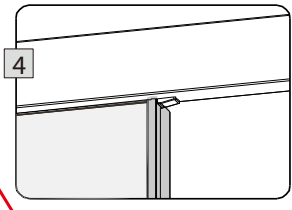
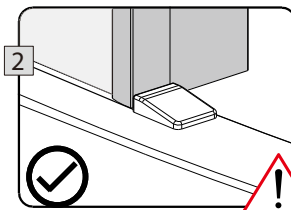
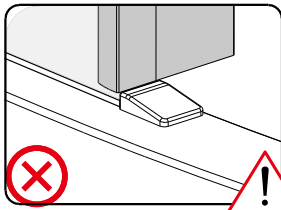
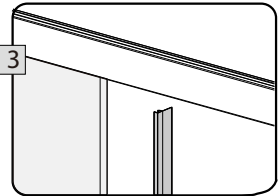
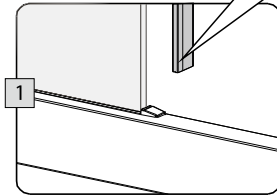
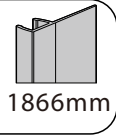

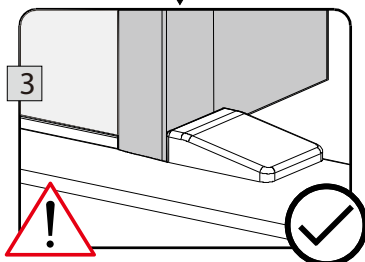
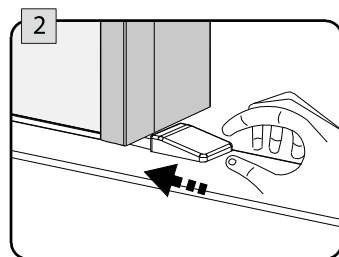
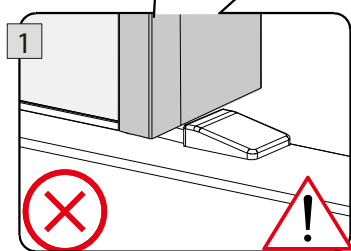
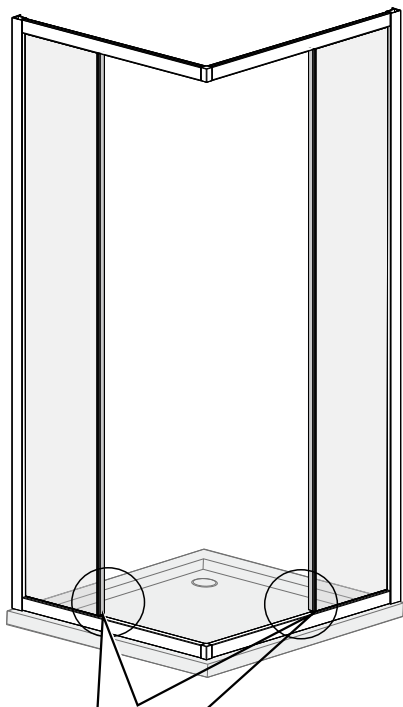

9

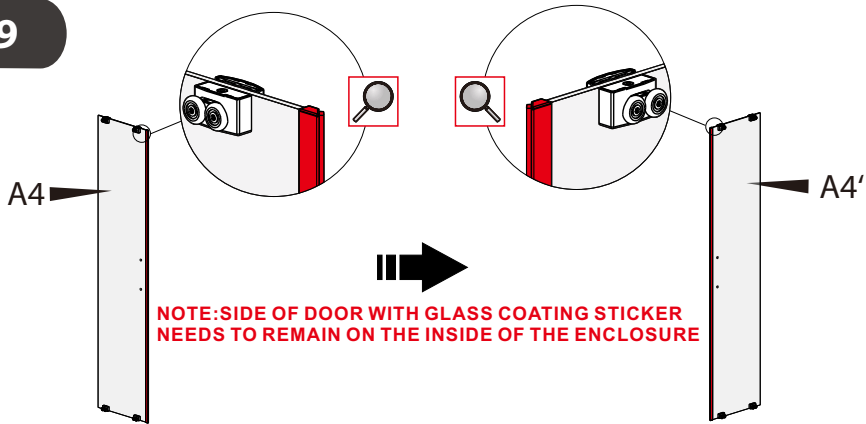

1-6 Removal of Wheels
7 Rotate door around
8-13 Reattaching Wheels

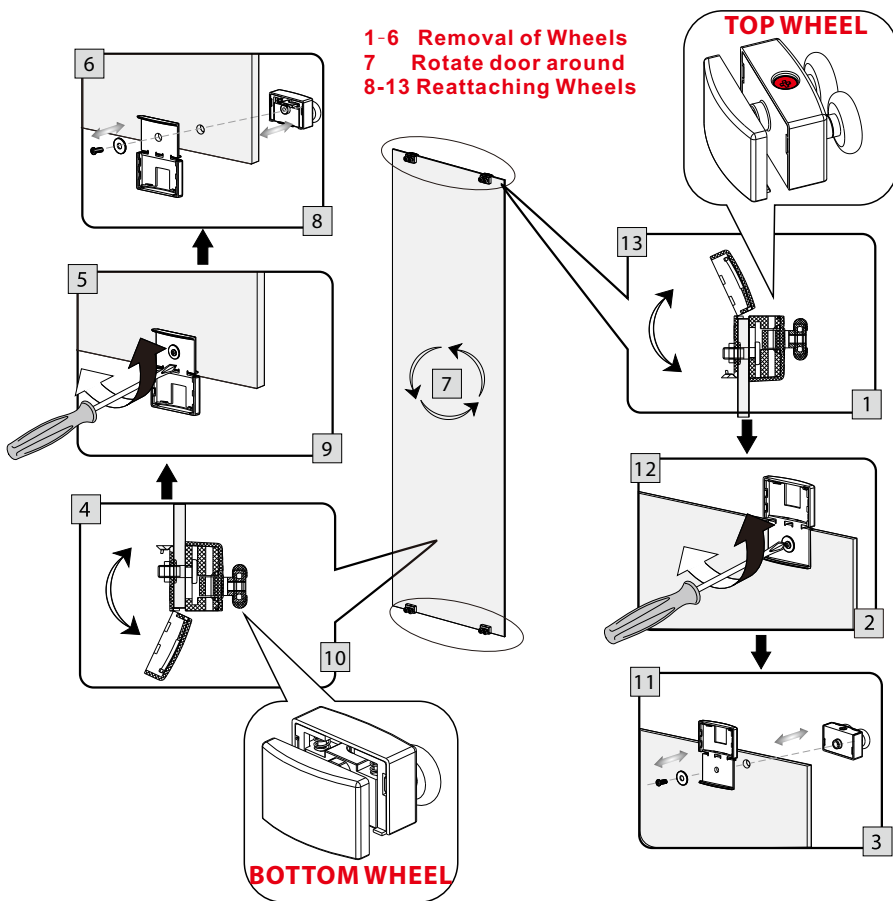

C2 x2



1927mm

2

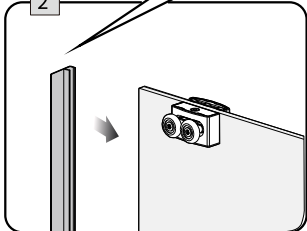

3

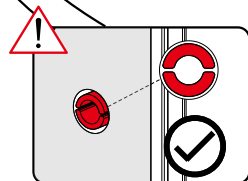
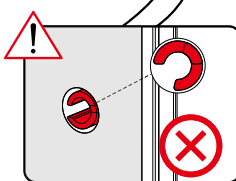
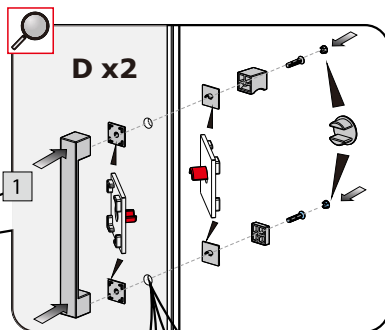
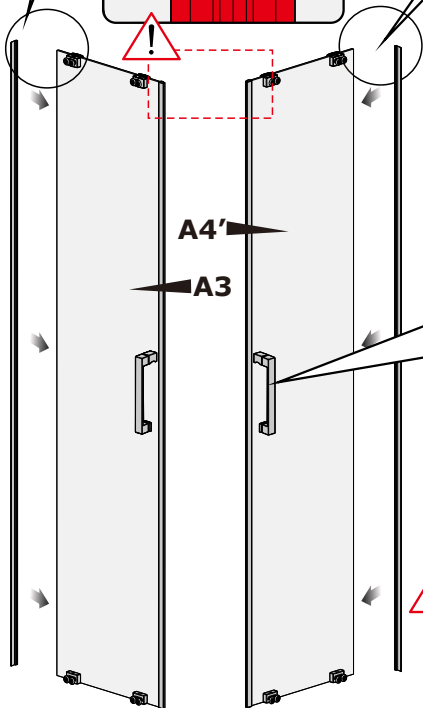
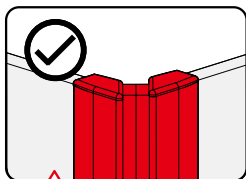
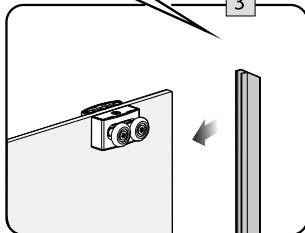

11

ENSURE TOP WHEELS ARE ALIGNED

TOP WHEELS

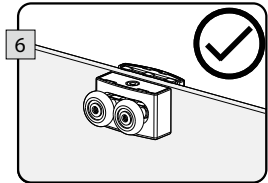
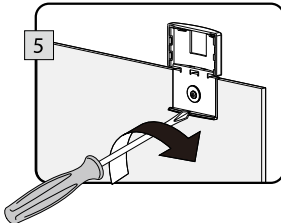
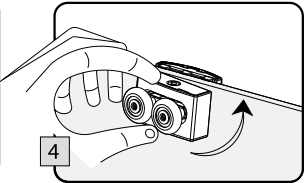
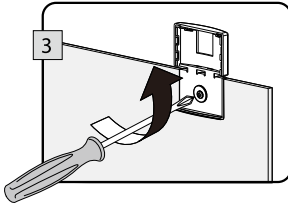
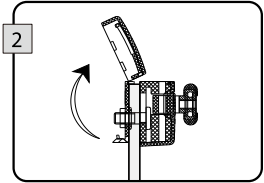
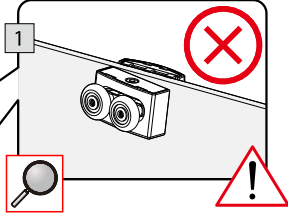
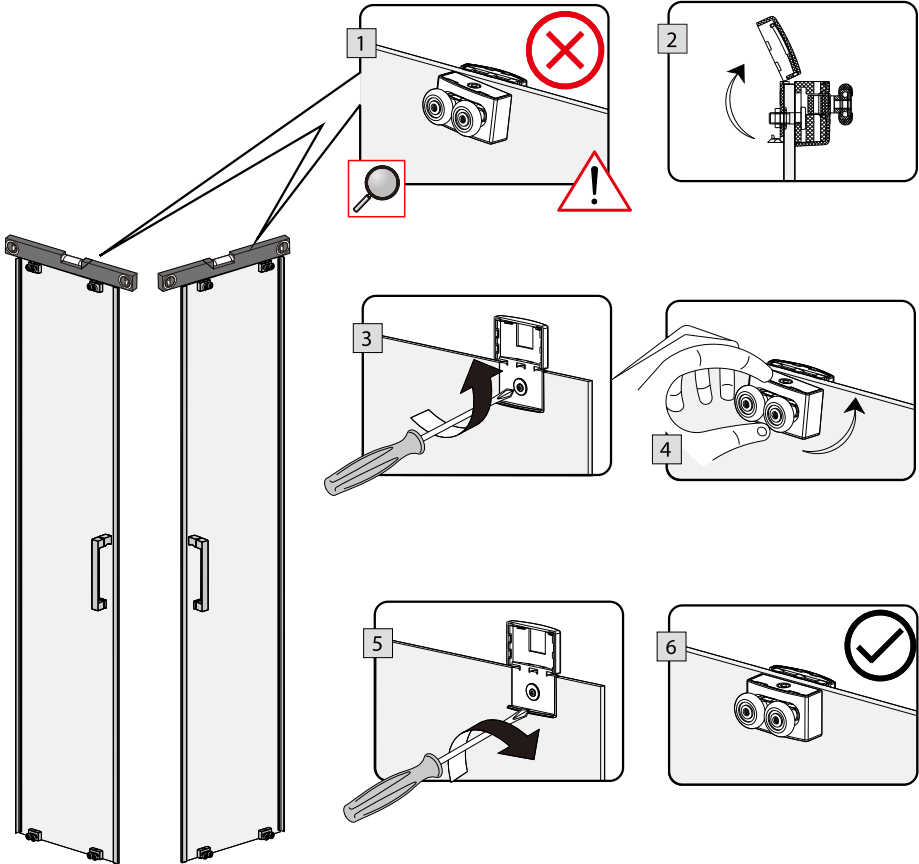
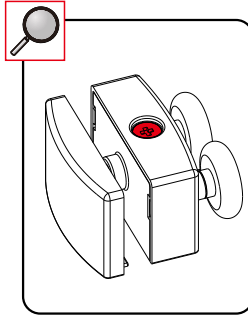
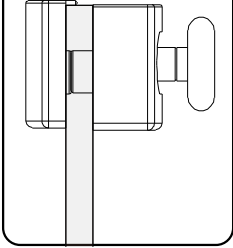

ENSURE BOTTOM WHEELS ARE ALIGNED

12

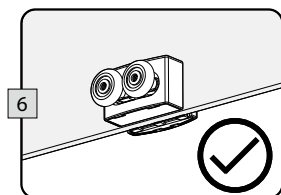
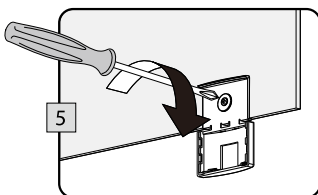
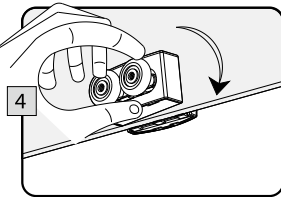
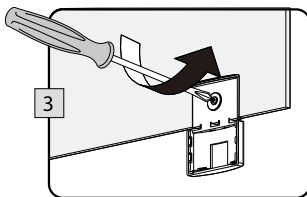
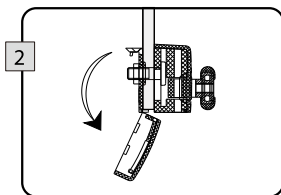
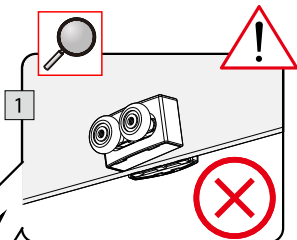
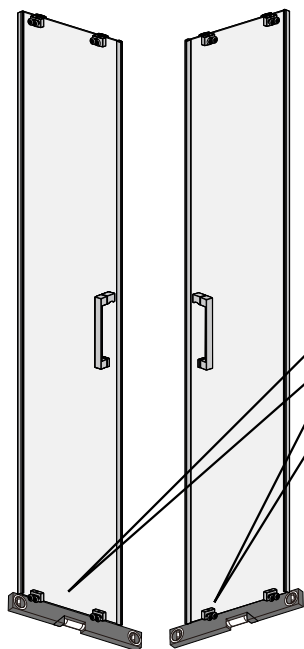
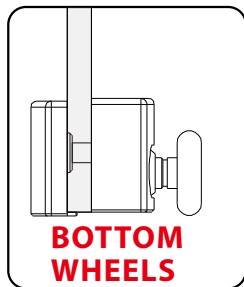
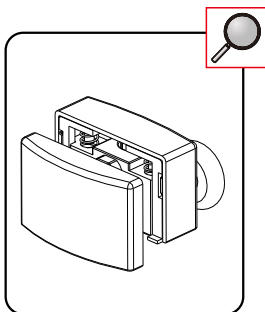

13

TOP WHEELS

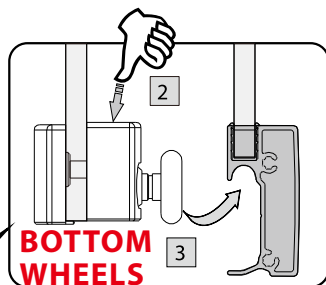
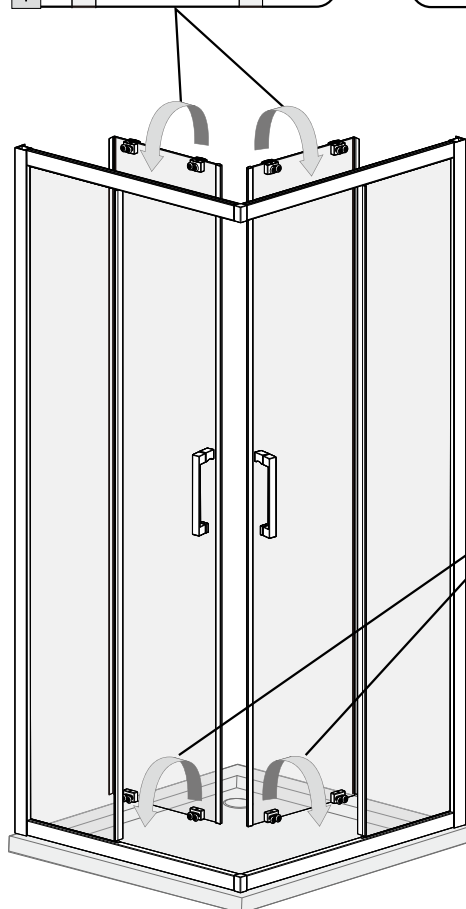
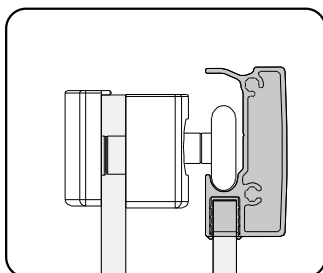
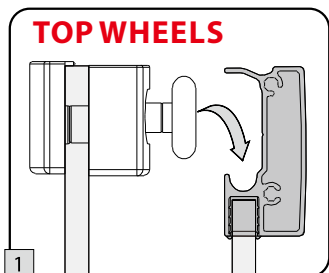

BOTTOM WHEELS

3

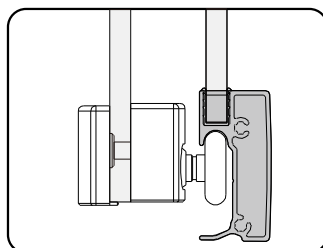

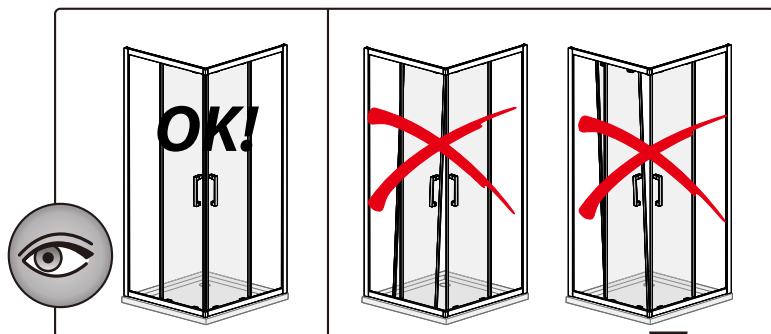
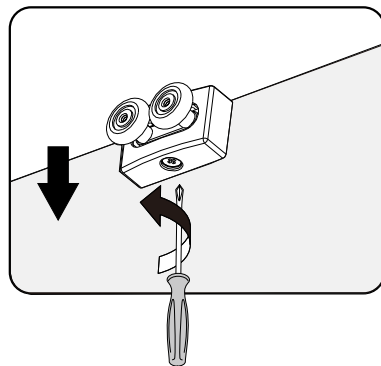
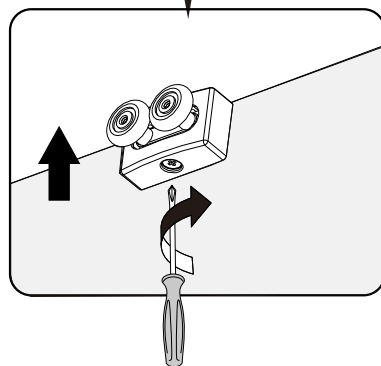
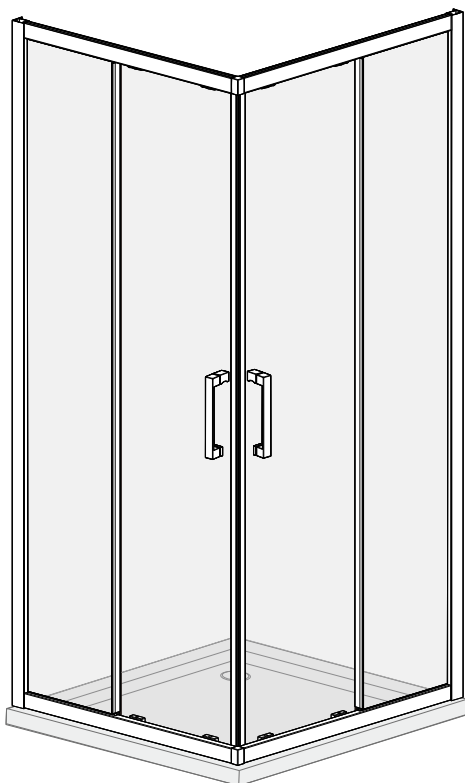
**TOP WHEEL ADJUSTMENT**

15

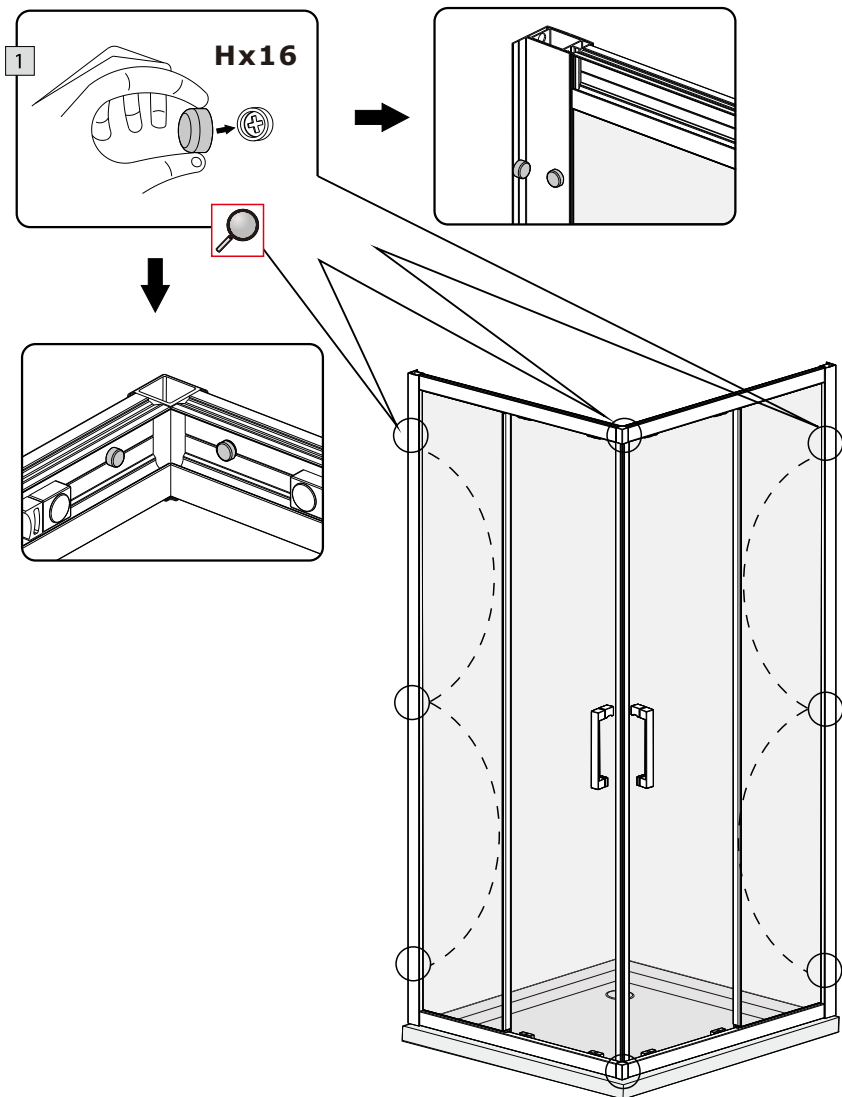

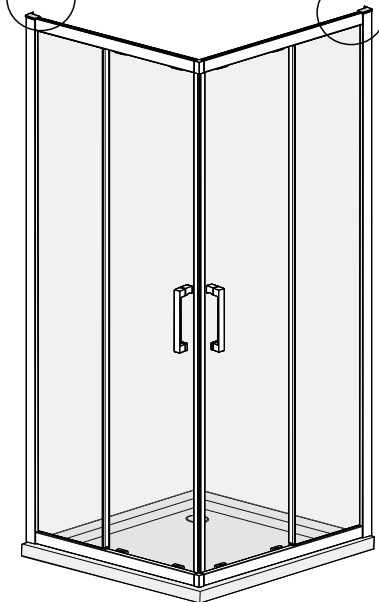
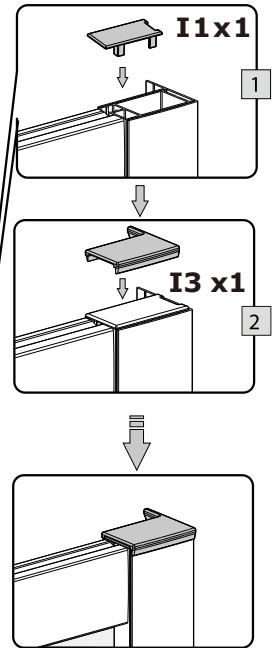
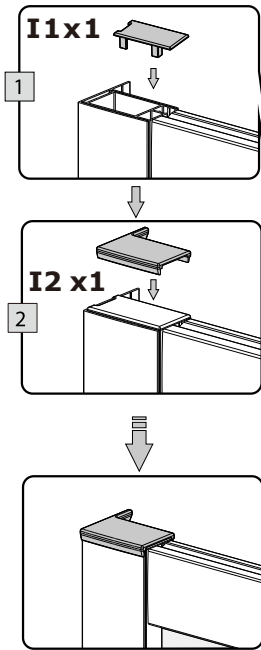

17

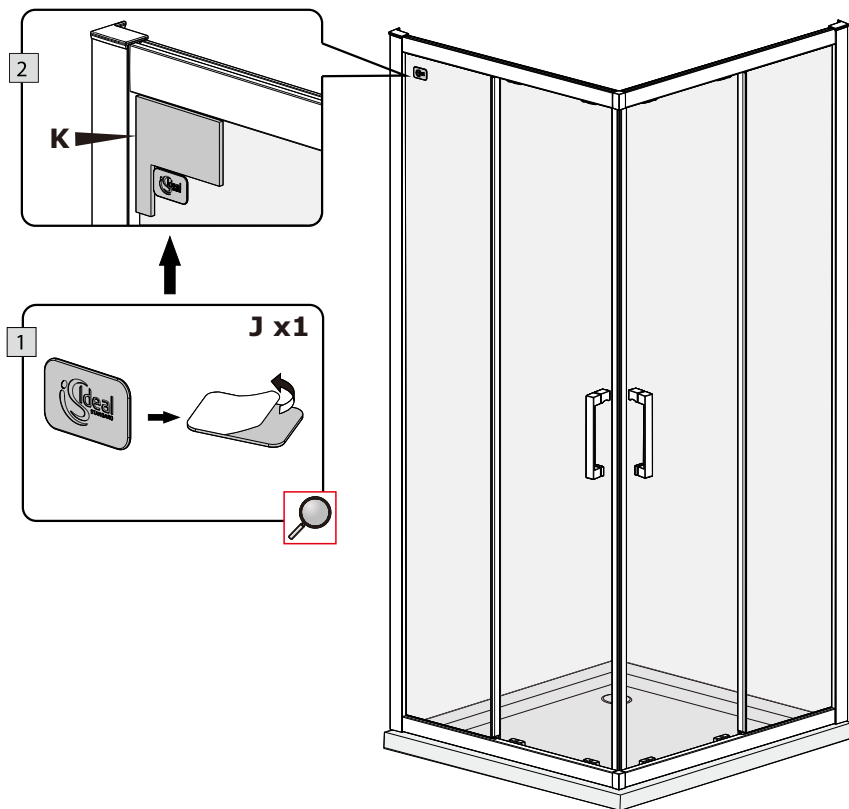

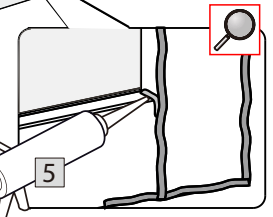
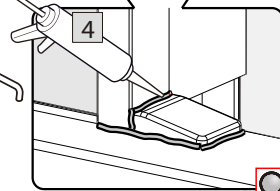
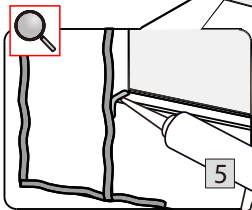
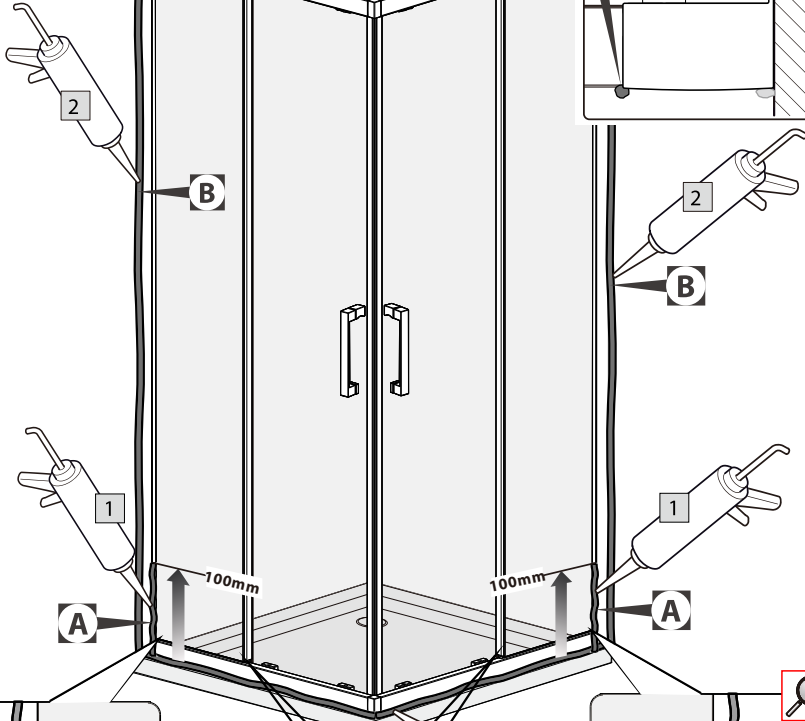
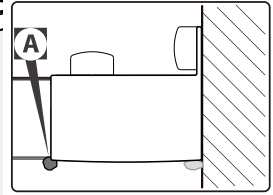
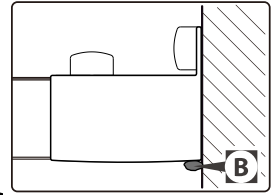
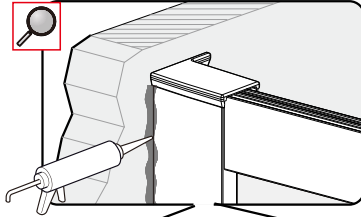



The Bathroom Works
National Avenue
Kingston upon Hull
HU5 4HS England
Telephone: (01482) 346461
Telefax: (01482) 445886.

CUSTOMER CARE HELPLINE

0870 1296085

CUSTOMER CARE FAX LINE 01482 499611

email: ukcustcare@IdealStandard.com

Ideal Standard pursues a policy of continuing improvement in design and performance of its products. The right is, therefore, reserved to vary specifications without notice.

