

# SPARE PARTS

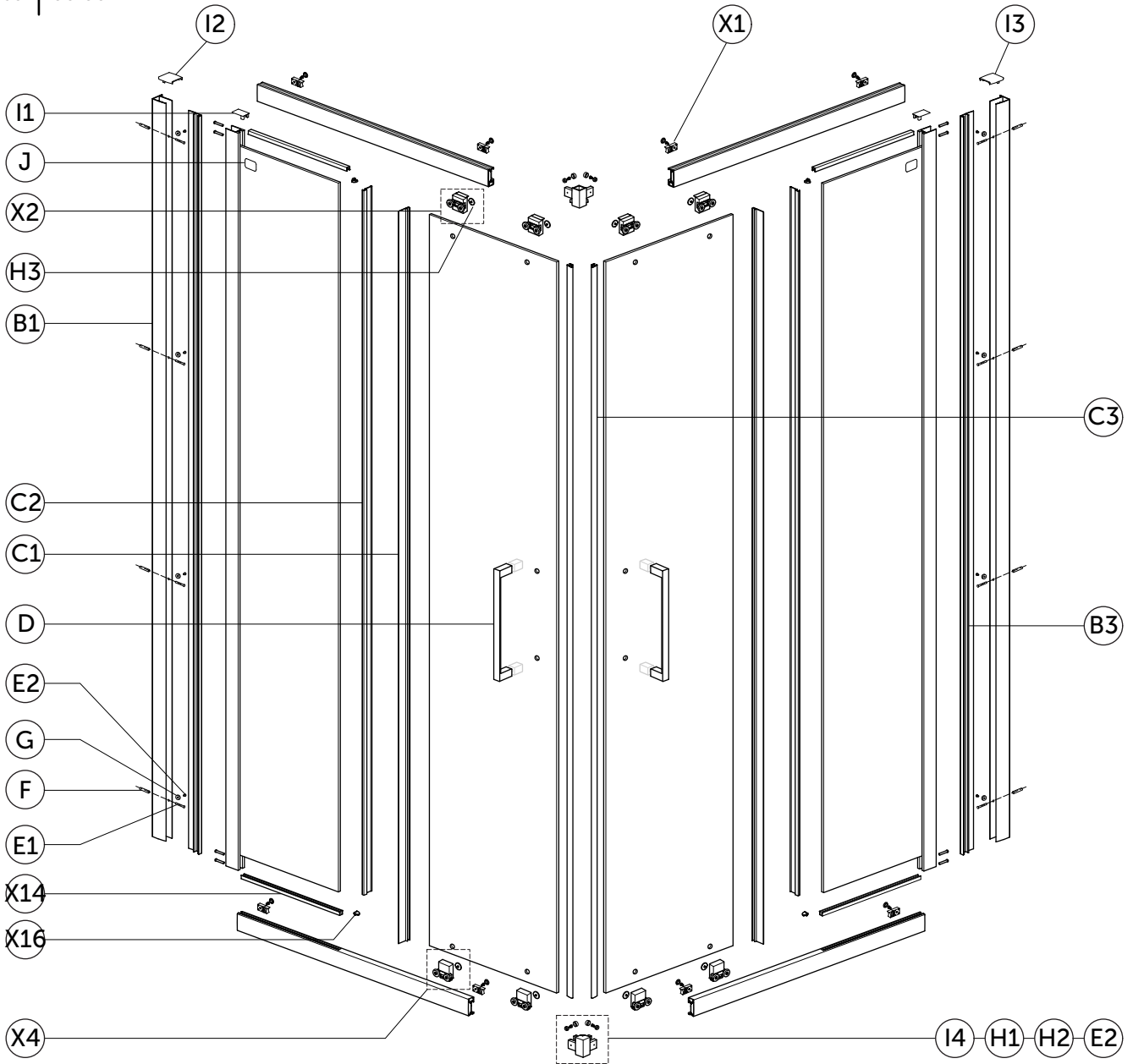







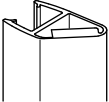

Corner Entry UK



I.LIFE



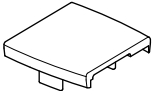
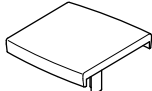
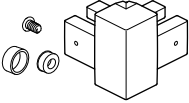

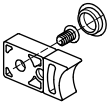
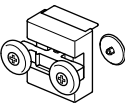
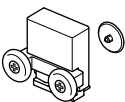

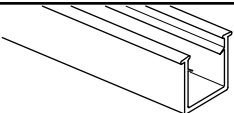
T4977	T4978
80x80	90x90

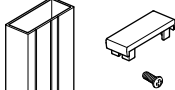

Item	ERP Code	Drawing	Description	Remark	SKU
B1	LY-JC310-01		Wall profile (UK - 25mm Adjustment)	1pc, length 2000mm, 8 holes pre-drilled	TR006EO
B3	LY-JC310-02		Wall cover profile (UK - 25mm Adjustment)	1pc, length 2000mm	TR014EO
C1	308-606		Vertical anti-water seal for 8mm door panel	1pc, length 1983mm	TR07167
C2	308-607		Vertical anti-water seal for 8mm fixed panel	1pc, length 1909mm	

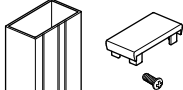
Item	ERP Code	Drawing	Description	Remark	SKU
C3	308-296		Door vertical magnet seal (CE/QUAD) - UK	1pc, length 1983mm	TR14067
D	LY-MB812-88		Single Handle - 380mm centres	complete set	TR099AA
E1	LY-JC200-10		Installation pack fixing wall jamb on wall	TCB 3.9X30 : x8pcs	TR03667
E2				TCB 3.9X9 : x8pcs	
F				wall plug: x8pcs	
G				cover profile clip moulding : x8pcs	
E1			Screws fixing vertical profile with rail profile	TCB 3.9X30 : x8pcs	TR03767
H3	LY-MB810-05		Flush Cover Cap for Wheel Assemblies	1pc	TR108AA
I1	LY-JC310-50		cover for vertical profile (UK - 25mm Adjustment)		TR114AA
I2	LY-JC310-53		Top cover for wall profile LH (UK - 25mm Adjustment)		TR115AA
I3	LY-JC310-52		Top cover for wall profile RH (UK - 25mm Adjustment)		TR116AA
I4 H1 H2 E2			Connector with screw pack	TCB 3.9X8 : x2pcs screw white ring : x2pcs screw chrome cap : x2pcs connector: x1pc	TR118AA
J			S.S. sticker with positioning template	x1 complete set	KV29567
X1			Door Stop	complete set including mounting screw	TR066AH
X2	LY-MB810-07		Roller / Top - STANDARD	complete set (screw, covers, etc..)	TR125AA
X4	LY-MB810-13		Roller /Bottom	complete set (screw, covers, etc..)	TR126AA

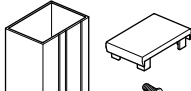
Item	ERP Code	Drawing	Description	Remark	SKU
X14	308-605		U shape anti-water seal (for 8mm glass)	1pc. length 850mm	TR07267
X16	LY-MB810-80		Slot cover (pair)	2pc in a pair	TR109AA

X8	2258003; LY-JC310-51		15mm Extension profile, cover cap and x8 ST4x10 screws	holes pre-drilled	T4893EO
X11	LY-JC310-51		15mm Extension profile cover cap		TR111AA
X9	220651; LY-MB810-82		20mm Extension profile, cover cap and x8 ST4x10 screws	holes pre-drilled	T4894EO
X12	LY-MB810-82		20mm Extension profile cover cap		TR112AA
X10	220650; LY-MB810-81		25mm Extension profile, cover cap and x8 ST4x10 screws	holes pre-drilled	T4895EO
X13	LY-MB810-81		25mm Extension profile cover cap		TR113AA

Ideal Standard International NV  
Corporate Village – Gent Building  
Da Vincilaan 2  
B1935 – Zaventem  
Belgium

**BE** +32 (02) 325 66 33  
**BG** +359 675 30362  
**DE** +49 (0)228 521 580  
**EG** +202 26969700  
**FR** +33 (0)1 49 38 28 00  
**GB** 01482 496 318

**GR** +30 210 67 90 810  
**HR** +38591 22 99 304  
**HU** +36 30 6991 594  
**IT** 800 652 290  
**ME** +971 4 804 2400  
**NL** +31 (077) 355 08 08

**PL** +48 71 7868 301/302  
**RO** +40 21 3223 201/202  
**SI** 00386 59 919040  
**TR** +90 216 314 87 87  
**UA** +359 675 30468  
**AL/XK/BA** +359 887 709 696

**CZ/SK** +420 417 592 179  
**DK/NO/SE** +45 75 84 10 10  
**ES/PT** +34 93 561 80 00  
**LV/LT/EE** +371 673 57 792  
**RS/MK/ME** +381 11 713 80 58  
**RU/MD** +7 495 669 23 11