

# SPARE PARTS

1200 Pivot UK







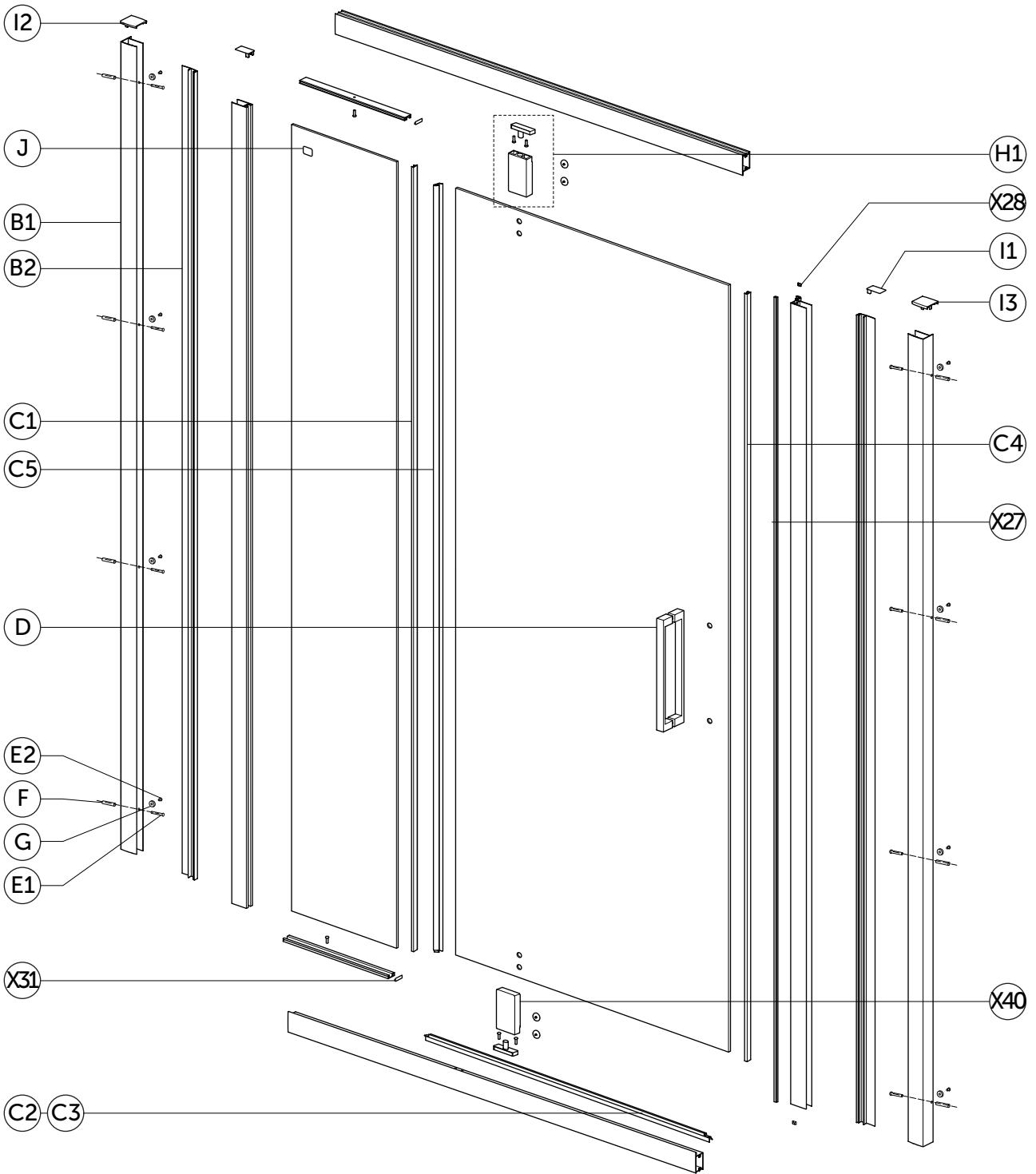

I.LIFE

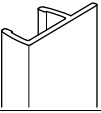
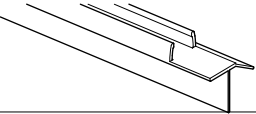
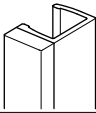
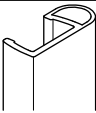

T4965



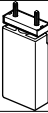

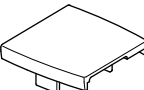
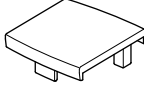
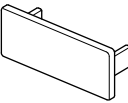
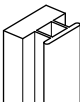

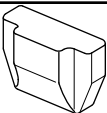
120

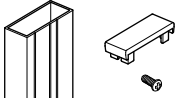

Item	ERP Code	Drawing	Description	Remark	SKU
B1	LY-JC310-01		Wall profile (UK - 25mm Adjustment)	length 2000mm, with 8 holes pre-drilled	TR006EO
B2	LY-JC310-02		Wall cover profile (UK - 25mm Adjustment)	length 2000mm	TR014EO

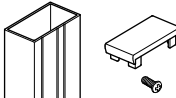
Item	ERP Code	Drawing	Description	Remark	SKU
C1	308-367		Vertical Panel anti-water seal	length 1914mm	TR07367
C2 C3	308-621		Bottom Flap seal 1200 - UK (Pair)	with 8mm & 6mm notch on each end LH & RH Seal length 755mm	TR15667
C4	308-620		Magnetic sealer	magnet sealer 1896mm: x1pc	TR15467
C5	308-611		Vertical Door anti-water seal	length 1899mm	TR08767
D	LY-MB810-116		Double Handle - 380mm centres	complete set	TR098AA
E1			Installation pack fixing wall jamb on wall	TCB 3.9X30 : x8pcs	TR03667
E2				TCB 3.9X9 : x8pcs	
F				wall plug: x8pcs	
G				cover profile clip moulding : x8pcs	
H1			Pivot with covers and installation screws		TR128AA
J			S.S. sticker with positioning template		KV29567
I1	LY-JC310-50		cover for vertical profile (UK - 25mm Adjustment)	1pc	TR114AA
I2	LY-JC310-53		Top cover for wall profile LH (UK - 25mm Adjustment)	1pc	TR115AA
I3	LY-JC310-52		Top cover for wall profile RH (UK - 25mm Adjustment)	1pc	TR116AA
X31	LY-MB810-86		Panel Retainer Pack	1pc only	TR130AA
X27	LY-MB615-20		Pivot Frame Magnet Seal	magnet sealer 1990mm: x1pc	TR03467

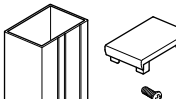
Item	ERP Code	Drawing	Description	Remark	SKU
X28	LY-MB615-13		Stopper for the magnetic seal on fixing profile side (pair)		TR069AH
X40	LY-MB815-07		Flush Cover Cap for Hinges & Pivots		TR159AA

X8	2258003; LY-JC310-51		15mm Extension profile, cover cap and x8 ST4x10 screws	holes pre-drilled	T4893EO
X11	LY-JC310-51		15mm Extension profile cover cap		TR111AA
X9	220651; LY-MB810-82		20mm Extension profile, cover cap and x8 ST4x10 screws	holes pre-drilled	T4894EO
X12	LY-MB810-82		20mm Extension profile cover cap		TR112AA
X10	220650; LY-MB810-81		25mm Extension profile, cover cap and x8 ST4x10 screws	holes pre-drilled	T4895EO
X13	LY-MB810-81		25mm Extension profile cover cap		TR113AA

Ideal Standard International NV  
Corporate Village – Gent Building  
Da Vincilaan 2  
B1935 – Zaventem  
Belgium

**BE** +32 (0)2 325 66 33  
**BG** +359 675 30362  
**DE** +49 (0)228 521 580  
**EG** +202 26969700  
**FR** +33 (0)1 49 38 28 00  
**GB** 01482 496 318

**GR** +30 210 67 90 810  
**HR** +38591 22 99 304  
**HU** +36 30 6991 594  
**IT** 800 652 290  
**ME** +971 4 804 2400  
**NL** +31 (0)77 355 08 08

**PL** +48 71 7868 301/302  
**RO** +40 21 3223 201/202  
**SI** 00386 59 919040  
**TR** +90 216 314 87 87  
**UA** +359 675 30468  
**AL/XK/BA** +359 887 709 696

**CZ/SK** +420 417 592 179  
**DK/NO/SE** +45 75 84 10 10  
**ES/PT** +34 93 561 80 00  
**LV/LT/EE** +371 673 57 792  
**RS/MK/ME** +381 11 713 80 58  
**RU/MD** +7 495 669 23 11