

# SPARE PARTS

Quadrant UK

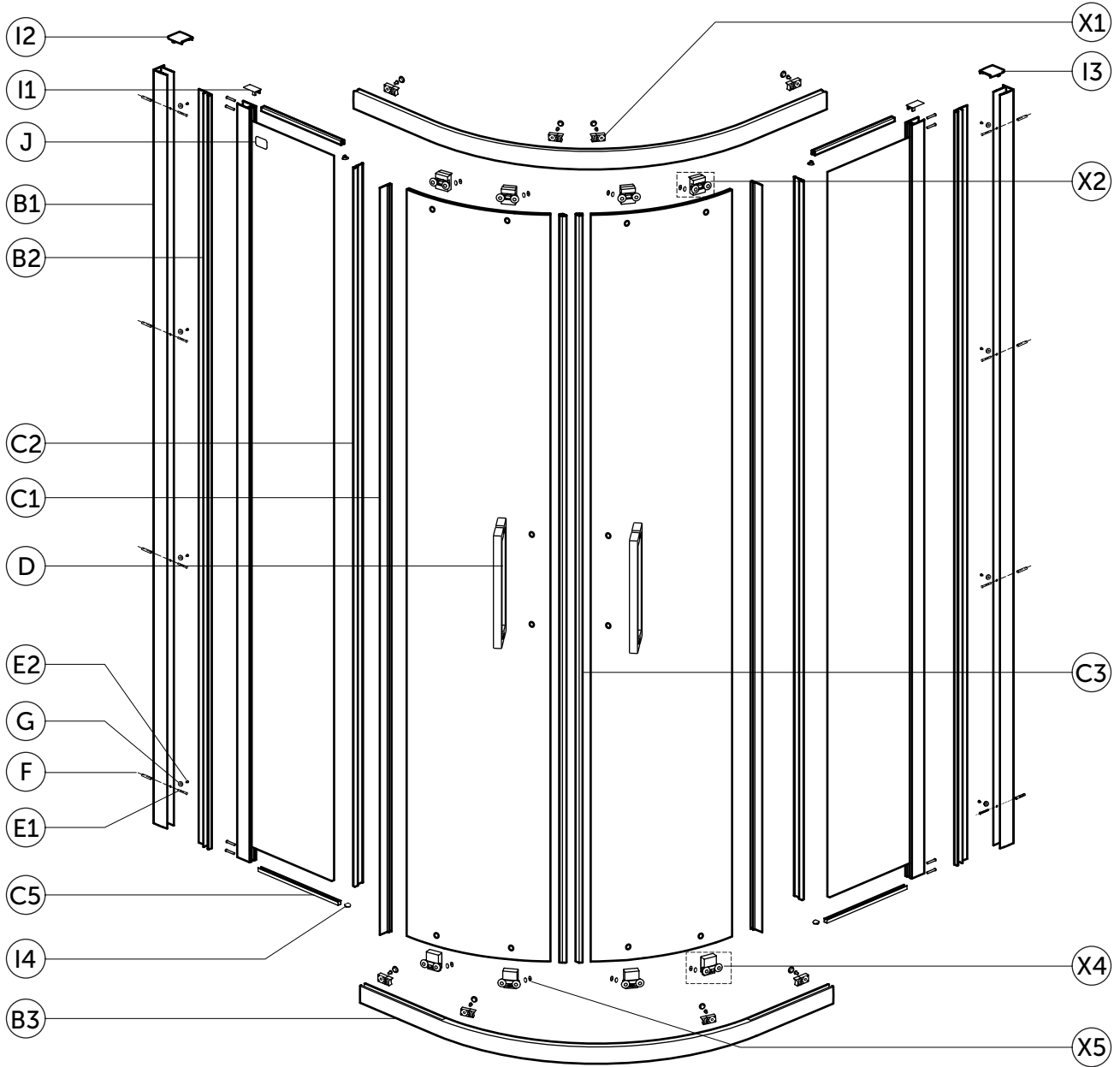

I.LIFE



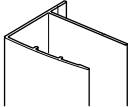
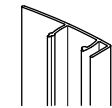

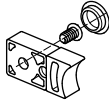
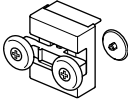
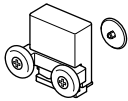

T4955	T4957	T4959	T4961	T4962	T4963	T4964
80x80	90x90	100x100	90x76	100x80	120x80	120x90

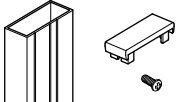

Item	ERP Code	Drawing	Description	Remark	SKU
B1	LY-JC310-01		Wall profile (UK - 25mm Adjustment)	1pc, length 2000mm, 8 holes pre-drilled	TR006EO
B2	LY-JC310-02		Wall cover profile (UK - 25mm Adjustment)	1pc, length 2000mm	TR014EO

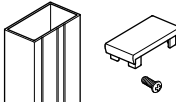
Item	ERP Code	Drawing	Description	Remark	SKU
B3	220646		Rail profile 80x80 - UK (individual)	1pc, holes pre-drilled, without slot cap without roller stopper	TR007EO
			Rail profile 90x90 - UK (individual)		TR008EO
			Rail profile 100x100 - UK (individual)		TR009EO
			Rail profile 90x76 LH & RH - UK Pair	2pc in a pair, without slot cap without roller stopper	TR010EO
			Rail profile 100x80 LH & RH - UK Pair		TR011EO
			Rail profile 120x80 LH & RH - UK Pair		TR012EO
			Rail profile 120x90 LH & RH - UK Pair		TR013EO
C1	308-606		Vertical anti-water seal for 8mm door panel	1pc, length 1983mm	TR07167
C2	308-607		Vertical anti-water seal for 8mm fixed panel	1pc, length 1909mm	
C3	308-296		Door vertical magnet seal (CE/QUAD) - UK	1pc, length 1983mm	TR14067
C5	308-605		U shape anti-water seal (for 8mm glass)	1pc, length 850mm	TR07267
D	LY-MB810-116		Double Handle - 380mm centres	x1 complete set	TR098AA
E1	LY-JC200-10		Installation pack fixing wall jamb on wall	TCB 3.9X30 : x8pcs	TR03667
E2				TCB 3.9X9 : x8pcs	
F				wall plug: x8pcs	
G				cover profile clip moulding : x8pcs	
E1			Screws fixing vertical profile with rail profile	TCB 3.9X30 : x8pcs	TR03767
I1	LY-JC310-50		cover for vertical profile (UK - 25mm Adjustment)	1pc	TR114AA
I2	LY-JC310-53		Top cover for wall profile LH (UK - 25mm Adjustment)	1pc	TR115AA
I3	LY-JC310-52		Top cover for wall profile RH (UK - 25mm Adjustment)	1pc	TR116AA
I4	LY-MB810-80		Slot cover (pair)	2pc in a pair	TR109AA

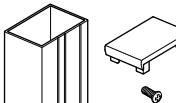
Item	ERP Code	Drawing	Description	Remark	SKU
J			S.S. sticker with positioning template	x1 complete set	KV29567
X1			Door Stop	complete set including mounting screw	TR066AH
X2	LY-MB810-07		Roller / Top - STANDARD	complete set (screw, covers, etc..)	TR125AA
X4	LY-MB810-13		Roller /Bottom	complete set (screw, covers, etc..)	TR126AA
X5	LY-MB810-05		Flush Cover Cap for Wheel Assemblies	1pc	TR108AA

X8	2258003; LY-JC310-51		15mm Extension profile, cover cap and x8 ST4x10 screws	holes pre-drilled	T4893EO
X11	LY-JC310-51		15mm Extension profile cover cap		TR111AA
X9	220651; LY-MB810-82		20mm Extension profile, cover cap and x8 ST4x10 screws	holes pre-drilled	T4894EO
X12	LY-MB810-82		20mm Extension profile cover cap		TR112AA
X10	220650; LY-MB810-81		25mm Extension profile, cover cap and x8 ST4x10 screws	holes pre-drilled	T4895EO
X13	LY-MB810-81		25mm Extension profile cover cap		TR113AA

Ideal Standard International NV  
Corporate Village – Gent Building  
Da Vincilaan 2  
B1935 – Zaventem  
Belgium

**BE** +32 (02) 325 66 33  
**BG** +359 675 30362  
**DE** +49 (0)228 521 580  
**EG** +202 26969700  
**FR** +33 (0)1 49 38 28 00  
**GB** 01482 496 318

**GR** +30 210 67 90 810  
**HR** +38591 22 99 304  
**HU** +36 30 6991 594  
**IT** 800 652 290  
**ME** +971 4 804 2400  
**NL** +31 (077) 355 08 08

**PL** +48 71 7868 301/302  
**RO** +40 21 3223 201/202  
**SI** 00386 59 919040  
**TR** +90 216 314 87 87  
**UA** +359 675 30468  
**AL/XK/BA** +359 887 709 696

**CZ/SK** +420 417 592 179  
**DK/NO/SE** +45 75 84 10 10  
**ES/PT** +34 93 561 80 00  
**LV/LT/EE** +371 673 57 792  
**RS/MK/ME** +381 11 713 80 58  
**RU/MD** +7 495 669 23 11